

# CONTENTS

INSTRUCTION FOR SERVICING(R32)	1
SAFETY PRECAUTIONS	6
PARTS AND FUNCTIONS	9
OPERATION INSTRUCTIONS	11
INSTALLATION PRECAUTIONS	12
INDOOR UNIT INSTALLATION	15
OUTDOOR UNIT INSTALLATION	27
TEST OPERATION	31
CARE AND MAINTENANCE	32
TROUBLESHOOTING	33
DISPOSAL GUIDELINE	36

\* The design and specifications are subject to change without prior notice for product improvement. Consult with the sales agency or manufacturer for details.

\* The shape and position of buttons and indicators may vary according to the model, but their function are the same.

# INSTRUCTION FOR SERVICING(R32)

1. Check the information in this manual to find out the dimensions of space needed for proper installation of the device, including the minimum distances allowed compared to adjacent structures.
2. Appliance shall be installed, operated and stored in a room with a floor area larger than 4m<sup>2</sup>.
3. The installation of pipe-work shall be kept to a minimum.
4. The pipe-work shall be protected from physical damage, and shall not be installed in an unventilated space if the space is smaller than 4m<sup>2</sup>.
5. The compliance with national gas regulations shall be observed.
6. The mechanical connections shall be accessible for maintenance purposes.
7. Follow the instructions given in this manual for handling, installing, cleaning, maintaining and disposing of the refrigerant.
8. Make sure ventilation openings clear of obstruction.
9. Notice: The servicing shall be performed only as recommended by the manufacturer.
10. Warning: The appliance shall be stored in a well-ventilated area where the room size corresponds to the room area as specified for operation.
11. Warning: The appliance shall be stored in a room without continuously operating open flames (for example an operating gas appliance) and ignition sources (for example an operating electric heater).
12. The appliance shall be stored so as to prevent mechanical damage from occurring.
13. It is appropriate that anyone who is called upon to work on a refrigerant circuit should hold a valid and up-to-date certificate from an assessment authority accredited by the industry and recognizing their competence to handle refrigerants, in accordance with the assessment specification recognized in the industrial sector concerned. Service operations should only be carried out in accordance with the recommendations of the equipment manufacturer. Maintenance and repair operations that require the assistance of other qualified persons must be conducted under the supervision of the person competent for the use of flammable refrigerants.
14. Every working procedure that affects safety means shall only be carried out by competent persons.
15. Warning:
  - \* Do not use any means to accelerate the defrosting process or clean the frost on your own. Follow the recommended guidelines from the manufacturer.
  - \* The appliance shall be stored in a room without continuously operating ignition sources (for example: open flames, an operating gas appliance or an operating electric heater).
  - \* Do not pierce or burn.
  - \* Be aware that refrigerants may not contain an odor.



Caution:Risk of fire



Read operator's manual



Operating instructions



Read technical manual

## INSTRUCTION FOR SERVICING(R32)

### 16. Information on servicing:

#### 1) Checks to the area

Prior to beginning work on systems containing flammable refrigerants, safety checks are necessary to ensure that the risk of ignition is minimized. For repair to the refrigerating system, the following precautions shall be complied with prior to conducting work on the system.

#### 2) Work procedure

Work shall be undertaken under a controlled procedure so as to minimize the risk of a flammable gas or vapor being present while the work is being performed.

#### 3) General work area

All maintenance staff and others working in the local area shall be instructed on the nature of work being carried out. Work in confined spaces shall be avoided. The area around the workspace shall be sectioned off. Ensure that the conditions within the area have been made safe by control of flammable material

#### 4) Checking for presence of refrigerant

The area shall be checked with an appropriate refrigerant detector prior to and during work, to ensure the technician is aware of potentially flammable atmospheres. Ensure that the leak detection equipment being used is suitable for use with flammable refrigerants, i.e. non-sparking, adequately sealed or intrinsically safe.

#### 5) Presence of fire extinguisher

If any hot work is to be conducted on the refrigeration equipment or any associated parts, appropriate fire extinguishing equipment shall be available to hand. Have a dry powder or CO<sub>2</sub> fire extinguisher adjacent to the charging area.

#### 6) No ignition sources

No person carrying out work in relation to a refrigeration system which involves exposing any pipe work shall use any sources of ignition in such a manner that it may lead to the risk of fire or explosion. All possible ignition sources, including cigarette smoking, should be kept sufficiently far away from the site of installation, repairing, removing and disposal, during which refrigerant can possibly be released to the surrounding space. Prior to work taking place, the area around the equipment is to be surveyed to make sure that there are no flammable hazards or ignition risks. "No Smoking" signs shall be displayed.

#### 7) Ventilated area

Ensure that the area is in the open or that it is adequately ventilated before breaking into the system or conducting any work that will produce heat. A degree of ventilation shall continue during the period that the work is carried out.

The ventilation should safely disperse any released refrigerant and preferably expel it externally into the atmosphere.

#### 8) Checks to the refrigeration equipment

Where electrical components are being changed, they shall be fit for the purpose and to the correct specification. At all times the manufacturer's maintenance and service guidelines shall be followed.

If in doubt consult the manufacturer's technical department for assistance.

## INSTRUCTION FOR SERVICING(R32)

The following checks shall be applied to installations using flammable refrigerants:

- The charge size is in accordance with the room size within which the refrigerant containing parts are installed;
- The ventilation machinery and outlets are operating adequately and are not obstructed;
- If an indirect refrigerating circuit is being used, the secondary circuit shall be checked for the presence of refrigerant;
- Marking to the equipment continues to be visible and legible. Markings and signs that are illegible shall be corrected;
- Refrigeration pipe or components are installed in a position where they are unlikely to be exposed to any substance which may corrode refrigerant containing components, unless the components are constructed of materials which are inherently resistant to being corroded or are suitably protected against being so corroded.

### 9) Checks to electrical devices

Repair and maintenance to electrical components shall include initial safety checks and component inspection procedures. If a fault exists that could compromise safety, then no electrical supply shall be connected to the circuit until it is satisfactorily dealt with. If the fault cannot be corrected immediately but it is necessary to continue operation, an adequate temporary solution shall be used. This shall be reported to the owner of the equipment so all parties are advised.

Initial safety checks shall include:

- That capacitors are discharged: this shall be done in a safe manner to avoid possibility of sparking;
- That no live electrical components and wiring are exposed while charging, recovering or purging the system;
- That there is continuity of earth bonding.

### 17. Repairs to sealed components

- 1) During repairs to sealed components, all electrical supplies shall be disconnected from the equipment being worked upon prior to any removal of sealed covers, etc. If it is absolutely necessary to have an electrical supply to equipment during servicing, then a permanently operating form of leak detection shall be located at the most critical point to warn of a potentially hazardous situation.
- 2) Particular attention shall be paid to the following to ensure that by working on electrical components, the casing is not altered in such a way that the level of protection is affected. This shall include damage to cables, excessive number of connections, terminals not made to original specification, damage to seals, incorrect fitting of glands, etc. Ensure that apparatus is mounted securely. Ensure that seals or sealing materials have not degraded such that they no longer serve the purpose of preventing the ingress of flammable atmospheres. Replacement parts shall be in accordance with the manufacturer's specifications.

NOTE: The use of silicon sealant may inhibit the effectiveness of some types of leak detection equipment. Intrinsically safe components do not have to be isolated prior to working on them.

### 18. Repair to intrinsically safe components

Do not apply any permanent inductive or capacitance loads to the circuit without ensuring that this will not exceed the permissible voltage and current permitted for the equipment in use. Intrinsically safe components are the only types that can be worked on while live in the presence of a flammable atmosphere. The test apparatus shall be at the correct rating. Replace components only with parts specified by the manufacturer. Other parts may result in the ignition of refrigerant in the atmosphere from a leak.

# INSTRUCTION FOR SERVICING(R32)

## 19. Cabling

Check that cabling will not be subject to wear, corrosion, excessive pressure, vibration, sharp edges or any other adverse environmental effects. The check shall also take into account the effects of aging or continual vibration from sources such as compressors or fans.

## 20. Detection of flammable refrigerants

Under no circumstances shall potential sources of ignition be used in the searching for or detection of refrigerant leaks. A halide torch (or any other detector using a naked flame) shall not be used.

## 21. Leak detection methods

The following leak detection methods are deemed acceptable for systems containing flammable refrigerants.

Electronic leak detectors shall be used to detect flammable refrigerants, but the sensitivity may not be adequate, or may need re-calibration. (Detection equipment shall be calibrated in a refrigerant-free area.) Ensure that the detector is not a potential source of ignition and is suitable for the refrigerant used. Leak detection equipment shall be set at a percentage of the LFL of the refrigerant and shall be calibrated to the refrigerant employed and the appropriate percentage of gas (25 % maximum) is confirmed. Leak detection fluids are suitable for use with most refrigerants but the use of detergents containing chlorine shall be avoided as the chlorine may react with the refrigerant and corrode the copper pipe-work. If a leak is suspected, all naked flames shall be removed/ extinguished. If a leakage of refrigerant is found which requires brazing, all of the refrigerant shall be recovered from the system, or isolated (by means of shut off valves) in a part of the system remote from the leak. Oxygen free nitrogen (OFN) shall then be purged through the system both before and during the brazing process.

## 22. Removal and evacuation

When breaking into the refrigerant circuit to make repairs or for any other purpose conventional procedures shall be used. However, it is important that best practice is followed since inflammability is a consideration. The following procedure shall be adhered to:

- Remove refrigerant;
- Purge the circuit with inert gas;
- Evacuate;
- Purge again with inert gas;
- Open the circuit by cutting or brazing.

The refrigerant charge shall be recovered into the correct recovery cylinders. The system shall be flushed with OFN to render the unit safe. This process may need to be repeated several times. Compressed air or oxygen shall not be used for this task.

Flushing shall be achieved by breaking the vacuum in the system with OFN and continuing to fill until the working pressure is achieved, then venting to atmosphere, and finally pulling down to a vacuum. This process shall be repeated until no refrigerant is within the system. When the final OFN charge is used, the system shall be vented down to atmospheric pressure to enable work to take place. This operation is absolutely vital if brazing operations on the pipe-work are to take place.

Ensure that the outlet for the vacuum pump is not close to any ignition sources and there is ventilation available.

## 23. Decommissioning

Before carrying out this procedure, it is essential that the technician is completely familiar with the equipment and all its detail. It is recommended good practice that all refrigerants are recovered safely. Prior to the task being carried out, an oil and refrigerant sample shall be taken in case analysis is required prior to re-use of reclaimed refrigerant. It is essential that electrical power is available before the task is commenced.

# INSTRUCTION FOR SERVICING(R32)

- a) Become familiar with the equipment and its operation.
- b) Isolate system electrically.
- c) Before attempting the procedure,ensure that:
  - . mechanical handling equipment is available,if required,for handling refrigerant cylinders;
  - . all personal protective equipment is available and being used correctly;
  - . the recovery process is supervised at all times by a competent person;
  - . recovery equipment and cylinders conform to the appropriate standards.
- d) Pump down refrigerant system,if possible.
- e) If a vacuum is not possible,make a manifold so that refrigerant can be removed from various parts of the system.
- f) Make sure that cylinder is situated on the scales before recovery takes place.
- g) Start the recovery machine and operate in accordance with manufacturer's instructions.
- h) Do not overfill cylinders.(No more than 80% volume liquid charge).
- i) Do not exceed the maximum working pressure of the cylinder,even temporarily.
- j) When the cylinders have been filled correctly and the process completed,make sure that the cylinders and the equipment are removed from site promptly and all isolation valves on the equipment are closed off.
- k) Recovered refrigerant shall not be charged into another refrigeration system unless it has been cleaned and checked.

## 24. Labeling

Equipment shall be labled stating that it has been de-commissioned and emptied of refrigerant. The label shall be dated and signed. Ensure that there are labels on the equipment stating the equipment contains flammable refrigerant.

## 25. Recovery

When removing refrigerant from a system,either for servicing or decommissioning,it is recommended good practice that all refrigerants are removed safely.

When transferring refrigerant into cylinders,ensure that only appropriate refrigerant recovery cylinders are employed.Ensure that the correct number of cylinders for holding the total system charge are available.All cylinders to be used are designated for the recovered refrigerant and labled for that refrigerant(i.e.Special cylinders for he recovery of refrigerant).Cylinders shall be complete with pressure-relief valve and associated shut-off valves in good working order.

Empty recovery cylinders are evacuated and,if possible,cooled before recovery occurs.

The recovery equipment shall be in good working order with a set of instructions concerning the equipment that is at hand and shall be suitable for the recovery of all appriate refrigerants including,when applicable,flammable refrigerants.In addition,a set of calibrated weighing scales shall be available and in good working order.Hoses shall be complete with leak-free disconnect couplings and in good condition.Before using the recovery machine,check that it is in satisfactory working order,has been properly maintained and that any associated electrical components are sealed to prevent ignition in the event of a refrigerant release.Consult manufacturer if in doubt. The recovered refrigerant shall be returned to the refrigerant supplier in the correct recover cylinder,and the relevant waste transfer note arranged.Do not mix refrigerants in recovery units and especiallly not in cylinders.

If compressors or compressor oils are to be removed,ensure that they have been evacuated to an acceptable level to make certain that flammable refrigerant does not remain within the lubricant. The evacuation process shall be carried out prior to returning the compressor to the suppliers. Only electric heating to the compressor body shall be employed to accelerate this process.When oil is drained from a system,it shall be carried out safely.

# SAFETY PRECAUTIONS

## SAFETY RULES AND RECOMMENDATIONS FOR THE INSTALLER

1. **R**ead this guide before installing and using the appliance.
2. **D**uring the installation of the indoor and outdoor units, access to the working area should be forbidden to children. Unforeseeable accidents could happen.
3. **M**ake sure that the base of the outdoor unit is firmly fixed.
4. **C**heck that air cannot enter the refrigerant system and check for refrigerant leaks when moving the air conditioner.
5. **C**arry out a test cycle after installing the air conditioner and record the operating data.
6. **P**rotect the indoor unit with a fuse of suitable capacity for the maximum input current or with another overload protection device.
7. **E**nsure that the mains voltage corresponds to that stamped on the rating plate. Keep the switch or power plug clean. Insert the power plug correctly and firmly into the socket, thereby voiding the risk of electric shock or fire due to insufficient contact.
8. **C**heck that the socket is suitable for the plug, otherwise have the socket changed.
9. **T**he appliance must be fitted with means for disconnection from the supply mains having a contact separation in all poles that provide full disconnection under "over voltage category III conditions", and these means must be incorporated in the fixed wiring in accordance with the wiring rules.
10. **T**he air conditioner must be installed by professional or qualified persons.
11. **D**o not install the appliance at a distance of less than 50 cm from inflammable substances (alcohol, etc.) Or from pressurized containers (e.g. spray cans).
12. **I**f the appliance is used in areas without the possibility of ventilation, precautions must be taken to prevent any leaks of refrigerant gas from remaining in the environment and creating a danger of fire.
13. **T**he packaging materials are recyclable and should be disposed of in the separate waste bins. Take the air conditioner at the end of its useful life to a special waste collection center for disposal.
14. **O**nly use the air conditioner as instructed in this booklet. These instructions are not intended to cover every possible condition and situation. As with any electrical household appliance, common sense and caution are therefore always recommended for installation, operation and maintenance.
15. **T**he appliance must be installed in accordance with applicable national regulations.
16. **B**efore accessing the terminals, all the power circuits must be disconnected from the power supply.
17. **T**he appliance shall be installed in accordance with national wiring regulations.
18. **T**his appliance can be used by children aged from 8 years and above and persons with reduced physical, sensory or mental capabilities or lack of experience and knowledge if they have been given supervision or instruction concerning use of the appliance in a safe way and understand the hazards involved. Children shall not play with the appliance. Cleaning and user maintenance shall not be made by children without supervision.

# SAFETY PRECAUTIONS

## SAFETY RULES AND RECOMMENDATIONS FOR THE INSTALLER

19. **D**o not try to install the conditioner alone, always contact specialized technical personnel.
20. **C**leaning and maintenance must be carried out by specialized technical personnel. In any case disconnect the appliance from the mains electricity supply before carrying out any cleaning or maintenance.
21. **E**nsure that the mains voltage corresponds to that stamped on the rating plate. Keep the switch or power plug clean. Insert the power plug correctly and firmly into the socket, there by avoiding the risk of electric shock or fire due to insufficient contact.
22. **D**o not pull out the plug to switch off the appliance when it is in operation, since this could create a spark and cause a fire, etc.
23. **T**his appliance has been made for air conditioning domestic environments and must not be used for any other purpose, such as for drying clothes, cooling food, etc.
24. **A**lways use the appliance with the air filter mounted. The use of the conditioner without air filter could cause an excessive accumulation of dust or waste on the inner parts of the device with possible subsequent failures.
25. **T**he user is responsible for having the appliance installed by a qualified technician, who must check that earthing/grounding is done in accordance with current legislation and insert a thermos magnetic circuit breaker.
26. **T**he batteries in the remote controller must be recycled or disposed of properly. For disposal of scrap batteries, please discard the batteries as sorted municipal waste at the accessible collection point.
27. **N**ever remain directly exposed to the flow of cold air for a long time. The direct and prolonged exposition to cold air could be dangerous for your health. Particular care should be taken in the rooms where there are children, old or sick people.
28. **I**f the appliance gives off smoke or there is a smell of burning, immediately cut off the power supply and contact the Service Center.
29. **T**he prolonged use of the device in such conditions could cause fire or electrocution.
30. **H**ave repairs carried out only by an authorised Service Center of the manufacturer. Incorrect repair could expose the user to the risk of electric shock, etc.
31. **U**nhook the automatic switch if you foresee not to use the device for a long time. The airflow direction must be properly adjusted.
32. **T**he flaps must be directed downwards in the heating mode and upwards in the cooling mode.
33. **E**nsure that the appliance is disconnected from the power supply when it will remain inoperative for a long period and before carrying out any cleaning or maintenance.
34. **S**electing the most suitable temperature can prevent damage to the appliance.

# SAFETY PRECAUTIONS

## SAFETY RULES AND PROHIBITIONS

1. **D**o not bend, tug or compress the power cord since this could damage it. Electrical shocks or fire are probably due to a damaged power cord. Specialized technical personnel only must replace a damaged power cord.
2. **D**o not use extensions or gang modules.
3. **D**o not touch the appliance when barefoot or parts of the body are wet or damp.
4. **D**o not obstruct the air inlet or outlet of the indoor or the outdoor unit. The obstruction of these openings causes a reduction in the operative efficiency of the conditioner with possible consequent failures or damages.
5. **I**n no way alter the characteristics of the appliance.
6. **D**o not install the appliance in environments where the air could contain gas, oil or sulphur or near sources of heat.
7. **T**his appliance is not intended for use by persons (including children ) with reduced physical, sensory or mental capabilities, or lack of experience and knowledge, unless they have been given supervision or instruction concerning use of the appliance by a person responsible for their safety.
8. **D**o not climb onto or place any heavy or hot objects on top of the appliance.
9. **D**o not leave windows or doors open for long when the air conditioner is operating.
10. **D**o not direct the airflow onto plants or animals.
11. **A** long direct exposition to the flow of cold air of the conditioner could have negative effects on plants and animals.
12. **D**o not put the conditioner in contact with water. The electrical insulation could be damaged and thus causing electrocution.
13. **D**o not climb onto or place any objects on the outdoor unit.
14. **N**ever insert a stick or similar object into the appliance. It could cause injury.
15. **C**hildren should be supervised to ensure that they do not play with the appliance. If the supply cord is damaged, it must be replaced by the manufacturer, its service agent or similarly qualified persons in order to avoid a hazard.

# PARTS AND FUNCTIONS

## Indoor Unit

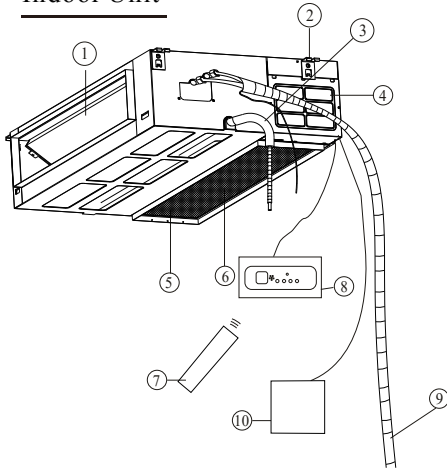

- ① Air Outlet
- ② Hook
- ③ Drainage Pipe
- ④ WiFi
- ⑤ Air Return
- ⑥ Filter
- ⑦ Remote controller  
(Available on some models only)
- ⑧ Remote controller receiver  
(Available on some models only)
- ⑨ Refrigerant connection pipe
- ⑩ Wired (Available on some models only)

## Outdoor Unit

<u>MULTI OUTDOOR UNIT</u>	
No.	Description
1	Air outlet
2	Valve Protective cover

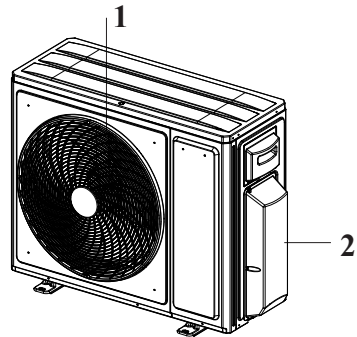

## SINGLE OUTDOOR UNIT

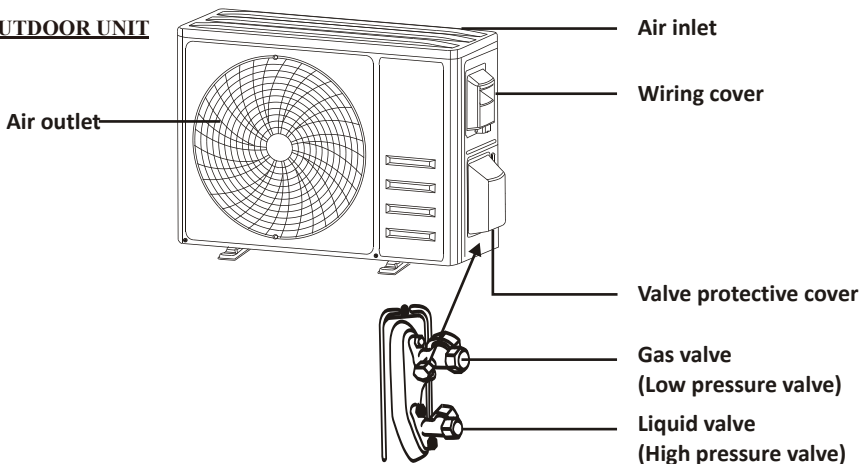

With the protective cover removed

Note: This figure shown may be different from the actual object. Please take the latter as the standard.

# PARTS AND FUNCTIONS

## Indoor display panel(Optional)

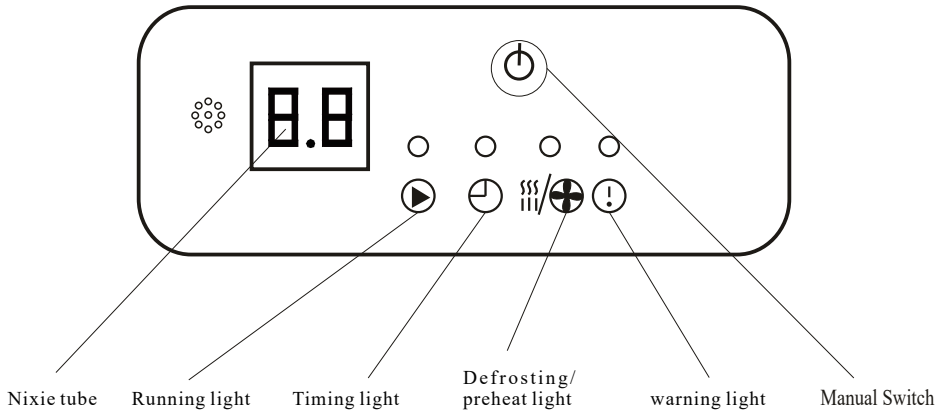

Display function declaration:

### LED light the state of running light

When powered-on the first time, the running light twinkles, while the double-8 does not lit.  
 When started-up normally, the running light lights on, while the double-8 shows the ambient temperature.  
 When operated normally, the running light lights on, while the double-8 shows the ambient temperature.  
 When closed down, both LED and double-8 are gone out.

### LED light the state of Timing light

When timing set, the timing light lights on, and the double-8 flash shows the time setting within 5 seconds, then shows the ambient temperature.  
 When without time setting, the timing light gone out, while the double-8 back to the original.

### LED light the state of defrosting/preheat light

When in the state of defrost, oil return, cold-wind proof, the defrosting/preheat light lights on, while the double-8 shows the designed temperature. (One-driven-one does not show the oil return state).  
 When out of the state of defrost, oil return, cold-wind proof, the defrosting/preheat light gone out, while the double-8 shows the designed temperature. (One-drive-one does not show the oil return state).

### LED light the state of warning light

When double-8 shows E\* or P\*, the running lights gone out, while the warning light lights on.

## 2. Trouble display of outdoor unit

- (1) During standby, the digital tube displays the numbers of indoor unit currently connected and communicating.
- (2) When the compressor operates, the digital tube displays the frequency value of the inverter compressor;
- (3) The digital tube displays "dxx" during defrosting;  
The digital tube displays "Cxx" during oil return.
- (4) During trouble protection, the information code displayed by the digital tube is as follows:

# OPERATION INSTRUCTIONS

- ❶ Attempt to use the air conditioner under the temperature beyond the specified range may cause the air conditioner protection device to start and the air conditioner may fail to operate. Therefore, try to use the air conditioner in the following temperature conditions.

## Inverter air conditioner:

MODE Temperature	Heating	Cooling	Dry
Room temperature	0°C~30°C	17°C~32°C	
Outdoor temperature	-20°C~30°C	-15°C~53°C	

With the power supply connected, restart the air conditioner after shutdown, or switch it to other mode during operation, and the air conditioner protection device will start. The compressor will resume operation after 3 minutes.

## ❶ Characteristics of heating operation (applicable to Heating pump)

### Preheating:

When the heating function is enabled, the indoor unit will take 2~5 minutes for preheating, after that the air conditioner will start heating and blows warm air.

### Defrosting:

During heating, when the outdoor unit frosted, the air conditioner will enable the automatic defrosting function to improve the heating effect. During defrosting, the indoor and outdoor fans stop running. The air conditioner will resume heating automatically after defrosting finish.

# INSTALLATION PRECAUTIONS(R32)

## Important Considerations

1. The air conditioner must be installed by professional personnel and the Installation manual is used only for the professional installation personnel! The installation specifications should be subject to our after-sale service regulations.
2. When filling the combustible refrigerant, any of your rude operations may cause serious injury or injuries to human body and objects.
3. A leak test must be done after the installation completed.
4. It is a must to do the safety inspection before maintaining or repairing an air conditioner using combustible refrigerant in order to ensure that the fire risk is reduced to minimum.
5. It is necessary to operate the machine under a controlled procedure in order to ensure that any risk arising from the combustible gas or vapor during the operation is reduced to minimum.
6. Requirements for the total weight of filled refrigerant and the area of a room to be equipped with an air conditioner (are shown as in the following Tables GG.1 and GG.2)

## The maximum charge and the required minimum floor area

$$m_1 = (4m^3) \times LFL, m_2 = (26m^3) \times LFL, m_3 = (130m^3) \times LFL$$

Where LFL is the lower flammable limit in kg/m<sup>3</sup>, R32 LFL is 0.306kg/m<sup>3</sup>.

For the appliances with a charge amount  $m_1 < M = m_2$ :

The maximum charge in a room shall be in accordance with the following:

$$m_{max} = 2.5 \times (LFL)^{(5/4)} \times h_0 \times (A)^{1/2}$$

The required minimum floor area A min to install an appliance with refrigerant charge M(kg)

shall be in accordance with following:  $A_{min} = (M / (2.5 \times (LFL)^{(5/4)} \times h_0))^2$

Where:

**Table GG.1 - Maximum charge (kg)**

Category	LFL (kg/m <sup>3</sup> )	h <sub>0</sub> (m)	Floor area (m <sup>2</sup> )						
			4	7	10	15	20	30	50
R32	0.306	1	1.14	1.51	1.8	2.2	2.54	3.12	4.02
		1.8	2.05	2.71	3.24	3.97	4.58	5.61	7.254
		2.2	2.5	3.31	3.96	4.85	5.6	6.86	8.85

**Table GG.2 - Minimum room area (m<sup>2</sup>)**

Category	LFL (kg/m <sup>3</sup> )	h <sub>0</sub> (m)	Charge amount (M) (kg)						
			Minimum room area (m <sup>2</sup> )						
R32	0.306	0.6	1.224kg	1.836kg	2.448kg	3.672kg	4.896kg	6.12kg	7.956kg
			0.6	29	51	116	206	321	543
			1	10	19	42	74	116	196
			1.8	3	6	13	23	36	60
			2.2	2	4	9	15	24	40

## Installation Safety Principles

### 1. Site Safety



Open Flames Prohibited



Ventilation Necessary

### 2. operation safety



Mind Static Electricity



Must wear protective clothing and anti-static gloves



Don't use mobile phone

## INSTALLATION PRECAUTIONS(R32)

3. Installation Safety
  - Refrigerant Leak Detector
  - Appropriate Installation Location



















The left picture is the schematic diagram of a refrigerant leak detector.

Please note that:

1. The installation site should be well-ventilated.
2. The sites for installing and maintaining an air conditioner using Refrigerant R32 should be free from open fire or welding, smoking, drying oven or any other heat source higher than 548 which easily produces open fire.
3. When installing an air conditioner, it is necessary to take appropriate anti-static measures such as wear anti-static clothing and/or gloves.
4. It is necessary to choose the site convenient for installation or maintenance wherein the air inlets and outlets of the indoor and outdoor units should be not surrounded by obstacles or close to any heat source or combustible and/or explosive environment.
5. If the indoor unit suffers refrigerant leak during the installation, it is necessary to immediately turn off the valve of the outdoor unit and all the personnel should go out till the refrigerant leaks completely for 15 minutes. If the product is damaged, it is a must to carry such damaged product back to the maintenance station and it is prohibited to weld the refrigerant pipe or conduct other operations on the user's site.
6. It is necessary to choose the place where the inlet and outlet air of the indoor unit is even.
7. It is necessary to avoid the places where there are other electrical products, power switch plugs and sockets, kitchen cabinet, bed, sofa and other valuables right under the lines on two sides of the indoor unit.

### Suggested Tools

Tool	Picture	Tool	Picture	Tool	Picture
Standard Wrench		Pipe Cutter		Vacuum Pump	
Adjustable/ Crescent Wrench		Screw drivers (Phillips & Flat blade)		Safety Glasses	
Torque Wrench		Manifold and Gauges		Work Gloves	
Hex Keys or Allen Wrenches		Level		Refrigerant Scale	
Drill & Drill Bits		Flaring tool		Micron Gauge	
Hole Saw		Clamp on Amp Meter			

# INSTALLATION PRECAUTIONS

## Pipe Length and Additional Refrigerant



Single Models ODU (Btu/h)	9K-12K	18K-24K
Length of pipe with standard charge	5m	5m
Maximum distance between indoor and outdoor unit	25m	25m
Additional refrigerant charge	15g/m	25g/m
Max. diff. in level between indoor and outdoor unit	10m	10m
Type of refrigerant	R32	R32

Multi Models ODU Capacity(Btu/h)	14K/18K	21K/27K	32K	42K
Max. equivalent length for all indoor units	40m	60m	80m	90m
Max. length to farthest indoor unit	25m	30m	30m	30m
Max. height difference between indoor and outdoor unit	15m	15m	15m	15m
Max. height difference between indoor unit	10m	10m	10m	10m
Standard refrigerant pipe length	10m	15m	20m	25m
Additional refrigerant charge (Based on the IDU)	15g/m	15g/m	15g/m	15g/m

## Torque Parameters

PIPE Size	Newton meter[N x m]	Pound-force foot (1bf-ft)	Kilogram-force meter (kgf-m)
1/4 " ( φ 6.35)	18 - 20	24.4 - 27.1	2.4 - 2.7
3/8 " ( φ 9.52)	30 - 35	40.6 - 47.4	4.1 - 4.8
1/2 " ( φ 12)	45 - 50	61.0 - 67.7	6.2 - 6.9
5/8 " ( φ 15.88)	60 - 65	81.3 - 88.1	8.2 - 8.9

## Dedicated Distribution Device and Wire for Air Conditioner

INVERTER TYPE		9k	12k	18k /24K	9k indoor	12k indoor	18k indoor	14/18k Outdoor	21/27/32/42K Outdoor
MODEL	capacity (Btu/h)	Sectional area for single models			Sectional area for Multi models				
Power supply cable (on outdoor)	N	1.5mm <sup>2</sup>	1.5mm <sup>2</sup>	1.5mm <sup>2</sup>				1.5mm <sup>2</sup>	2.5mm <sup>2</sup>
	L	1.5mm <sup>2</sup>	1.5mm <sup>2</sup>	1.5mm <sup>2</sup>				1.5mm <sup>2</sup>	2.5mm <sup>2</sup>
		1.5mm <sup>2</sup>	1.5mm <sup>2</sup>	1.5mm <sup>2</sup>				1.5mm <sup>2</sup>	2.5mm <sup>2</sup>
Connection cable	N	0.75mm <sup>2</sup>	0.75mm <sup>2</sup>	0.75mm <sup>2</sup>	0.75mm <sup>2</sup>	0.75mm <sup>2</sup>	0.75mm <sup>2</sup>	0.75mm <sup>2</sup>	0.75mm <sup>2</sup>
	L or (L)	0.75mm <sup>2</sup>	0.75mm <sup>2</sup>	0.75mm <sup>2</sup>	0.75mm <sup>2</sup>	0.75mm <sup>2</sup>	0.75mm <sup>2</sup>	0.75mm <sup>2</sup>	0.75mm <sup>2</sup>
	1	0.75mm <sup>2</sup>	0.75mm <sup>2</sup>	0.75mm <sup>2</sup>	0.75mm <sup>2</sup>	0.75mm <sup>2</sup>	0.75mm <sup>2</sup>	0.75mm <sup>2</sup>	0.75mm <sup>2</sup>
		0.75mm <sup>2</sup>	0.75mm <sup>2</sup>	0.75mm <sup>2</sup>	0.75mm <sup>2</sup>	0.75mm <sup>2</sup>	0.75mm <sup>2</sup>	0.75mm <sup>2</sup>	0.75mm <sup>2</sup>

# INDOOR UNIT INSTALLATION

## FIGURE OF BODY SIZE

1. The positioning of ceiling hole, indoor unit and hanging screw bolts.

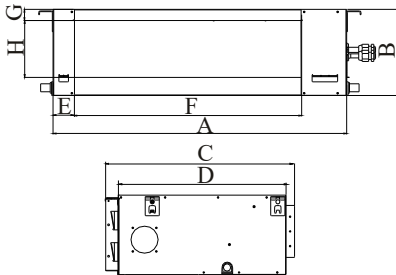

Air inlet size

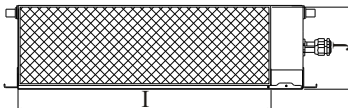

Position size of descensional ventilation opening.

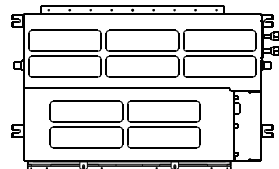

Size of mounted hook

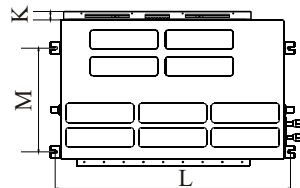

	Outline dimension				Air outlet opening size				Air return opening size			Size of mounted lug	
	A	B	C	D	E	F	G	H	I	J	K	L	M
9-18K	700	200	490	450	45	510	17	140	600	187	35	738	298
18K	920	200	490	450	45	730	17	140	820	187	35	958	298
24K	1100	200	490	450	27	930	17	140	1030	183	35	960	365

## CHOOSE INSTALLATION LOCATION

### ◆ INDOOR UNITS

1. A place where there are sufficient space for repair.
2. Hung ceiling that can bear the weight of the machine.
3. A place that air inlet and outlet is not hindered and without influence from outdoor air.
4. A place without heat source like smoke, fire or toxic pollution.
5. A place where air flow can be transmitted everywhere in the room.
6. A place convenient for installation.

Caution:(location in the following places may cause malfunction of the machine).

1. A place where there is flammable gas leakage.
2. There is salty air surrounding( near the coast).
3. There is caustic gas( the sulfide, for example) existing in the ai.
4. A place where can not bear the weight of the machine
5. In kitchen where it is full of oil gas.
6. There is strong electromagnetic wave existing.
7. There is acid or alkaline liquid evaporating.
8. A place where air circulation is not enough.
9. Other special surroundings.

# INDOOR UNIT INSTALLATION

## INSTALLATION

### Pre-installation precautions

● Please confirm that the installation personnel are qualified in relevant installation service. If the air conditioner was installed by persons without special skills, normal operations ensured, even the personal and estate safety would be affected.

The air conditioner must be correctly installed by installation technicians according to the attached «Installation Manual», and the user himself should not install it.

## USER GUIDELINE

- The user's installation site should be provided with regular power supply in conformity with that indicated in nameplate of the air conditioner, and its voltage should be within a range 90 % ~ 110 % of the rated voltage value.
- Please adopt the fuse or circuit breaker prescribed in Installation Instructions.
- Only qualified electrician is allowed to carry out wiring tasks strictly according to electric safety requirements.
- Do ensure good earth of air conditioner, in other words, the main power switch of air conditioner must be connected to reliable ground wired.

## PRECAUTIONS

- The air conditioner should be installed securely; otherwise poor installation may lead to abnormal noises and vibration.

## UNIT BODY INSTALLATION

Please confirm the indoor unit dimension according to the picture below. M10 whorl is to be installed. (4 sets)

- ◆ Please refer to the following for the center distance between the bolts
- ◆ M 10 whorl is used
- ◆ Please consult professional for your specific ceiling arrangement.

1. Dismantle scale of the ceiling.....please keep ceiling its level. Strengthen the beam to avoid vibration.
2. Break the beam of the ceiling.
3. Strengthen the breaking point of the ceiling and reinforce the ceiling beam.

- ◆ After the main body hanging is finished, arrangement of pipe and line will be done in the ceiling.

The direction of the pipe is determined after the installation location is chosen. If the ceiling has existed, please arrange the refrigerant pipe, drainage pipe, indoor and outdoor connecting line.

- ◆ Installation of the hanging screw bolt.

# INDOOR UNIT INSTALLATION

## CHOICE OF AIR RETURN WAYS

This indoor unit is fitted with downward air return, which can be change to its backward counterpart if necessary. Please follow the steps below to change it into the mode of air return backward.

### 1. Air return downward

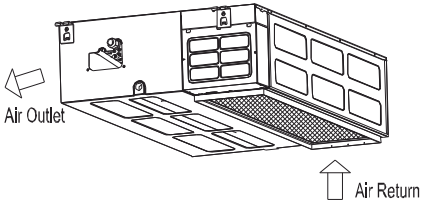

### 2. Loose the nut and dismantle flannel plate and filter; Loose the nut dismantel the back over.

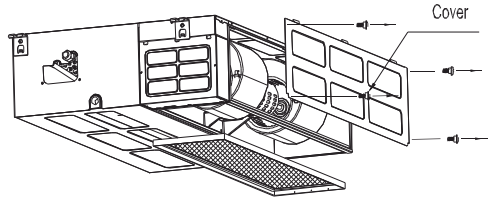

### 3. Install the flannel plate and filter at the backside; Install the cover to the downside.

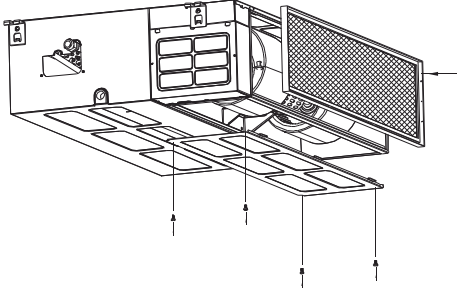

### 4. Air return backward.

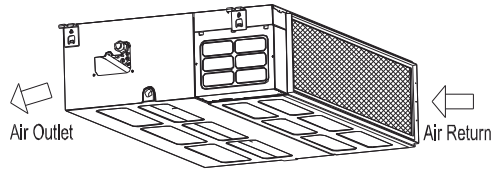

## INSTALLATION SPACE

Ensure sufficient space for installation and repair.

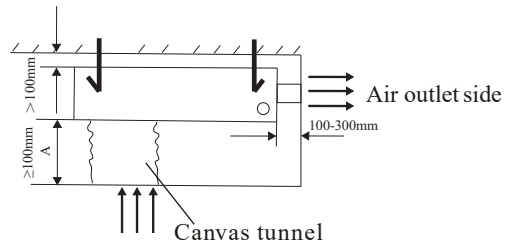

# INDOOR UNIT INSTALLATION

## WOODEN CONSTRUCTION

Put the square timber over the roof beam, then install the hanging screw bolt

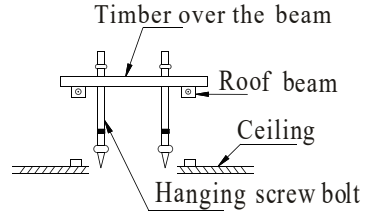

## NEW CONCRETE BRICKS

Inlaying or embedding the screw bolts

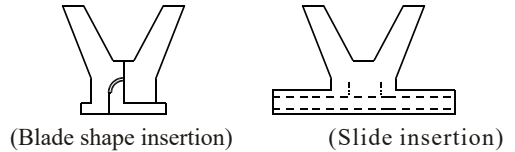

## FINISHED CONCRETE BRICKS

Install the hanging hook with expandible bolt into the concrete deep to 45-50mm to prevent loose.

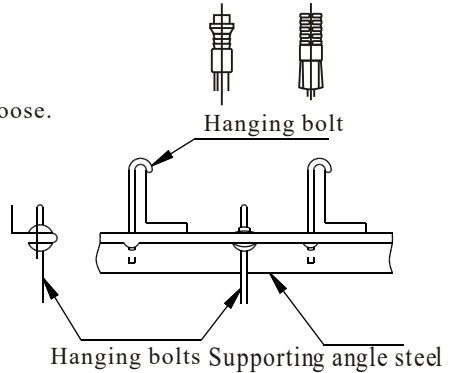

## STEEL ROOF BEAM STRUCTURE

Make use of steel in the ceiling or supporting angle steel.

## HANGING & INSTALLATION OF INDOOR UNIT

1. Adjust the nut position while the gap between gasket(downside) and ceiling should be confirmed according to actual situations.

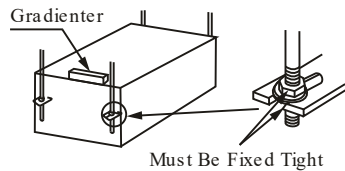
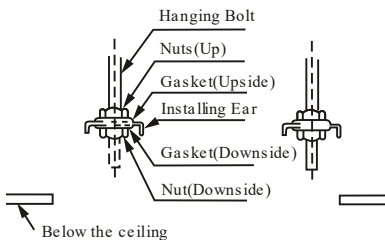

Hang the nut inside the U slot of the installation panel. To confirm level degree with gradienter. (Leaning downside toward non-draining side is prohibited)

The suspension height is not less than 2.4 meters.

# INDOOR UNIT INSTALLATION

## 2. How to mount outlet pipe

- Generally, we have two types of outlet pipe available, i.e. rectangular or round ones.
- Rectangular air conduit can be directly connected to air outlet of indoor unit by rivets. For outlet dimensions, see outline drawing of the unit.
- Round air conduit should be connected to a piece of transitional air conduit before it is connected to air outlet of indoor unit, the other end of it can be separately connected to air conduit window or connected to air conduit window after air flow diversion, and the total length should not be over 6m. As shown in figure below, air speeds at all air outlets should be set to basically consistent so as to meet the room air-conditioning requirements.

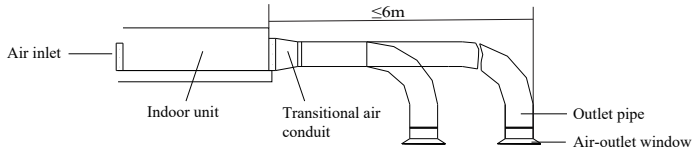

## 3. Installation method for return air pipe

- In case sidewise air intake is adopted, return air pipe should be fabricated and rivet-connected to return air orifice, and the other end of it should be connected to return air window.
- In case of underside air intake, purchase or fabricate a section of pleated canvas air conduit serving as transition joint for return air orifice and return air window. in this way, it can be freely adjusted according to height of indoor ceiling board; in addition, during operation of the unit, canvas air conduit may avoid vibration of ceiling board, as shown in figure below.

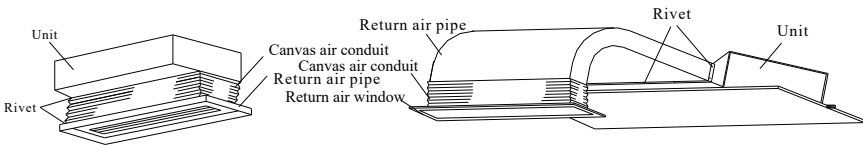

Installation mode for underside air intake

Installation mode for sidewise air intake

# INDOOR UNIT INSTALLATION

## 4. Tips for installation of return air pipe and outlet pipe

- To minimize energy loss occurring in transmission process and condensed water during heating operation, return air pipe and outlet pipe should be equipped with heat-insulating layer as shown in the figure.

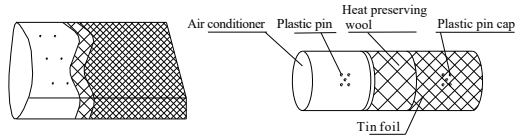

- Return air pipe and outlet pipe should be fixed to floor precast slabs by iron stand; in addition, all ports of the air conduit should be tightly sealed by gasket cement, and it is advisable that the edge clearance of return air pipe should be 150mm at least.

- Drain pipe for condensed water should be installed with minimum gradient of 1%, and the drain pipe should be insulated with heat-preserving pipe casing as well.

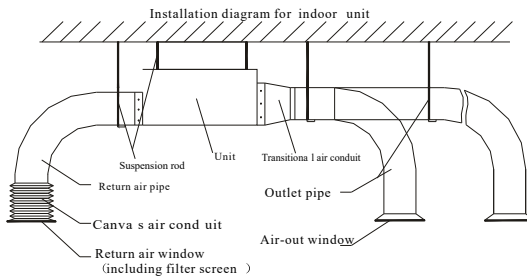

# INDOOR UNIT INSTALLATION

## LOW STAIIC PRESSURE DRAINAGE PIPE INSTALLATION

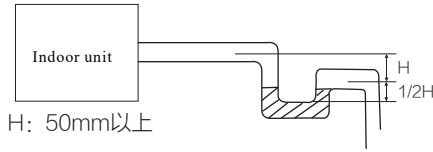

When the outlet of the drainage pipe is higher than the pumping nozzle of the main body, the drainage pipe should be vertically raised as far as possible. Vertical bending action, the overall lift under rated voltage 220V does not exceed 55cm, if the user has a special installation scenario. For example, if the user voltage is lower than the national grid standard, please contact the after-sales service or local installer to confirm the head height, otherwise the operation will stop. Time backflow can cause overflow.

### CAUTION

Be sure to follow this Installation Manual during drainage installation, the drainage pipe must have the heat insulation to prevent condensing.



- The drain pipe of indoor unit must have the heat insulation, or it will condense dew, as well as the connections of the indoor unit.
- The declivity of the drain pipe downwards should not be over 1/100, and no winding and bending.
- The total length of the drain pipe when pulled out transversely shall not exceed 20m, when the pipe is over long, a prop stand must be installed every 1.5 to 2m to prevent winding.
- Refer to the following figures about the installation of the pipes.
- Do not impose any pressure on the connection part of the drainage pipe.

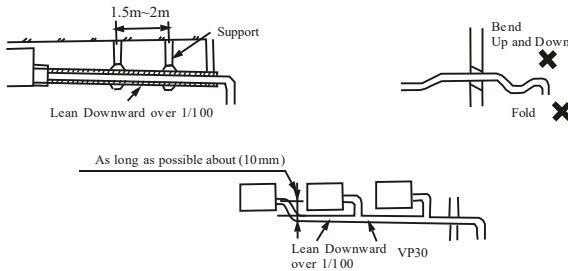

# INDOOR UNIT INSTALLATION

## DRAINAGE PIPE MATERIAL, HEAT-INSULATING MATERIAL

The listed material should be used:

Drainage Pipe Material	Polyvinyl chloride pipe (32mm outer diameter)
Heat Insulation Material	Foamed polyethylene insulation plate (10mm thickness)

### Connection Procedure

Connect the transparent pipe with the polyvinyl chloride pipe.

Use polyvinyl chloride glue at the connection part of the drainage pipe, be sure no water

- leakage.
- Paste glue at the front 40mm of the polyvinyl chloride pipe, insert it into the transparent pipe.
- It needs 10 minutes for the glue to dry. Do not impose pressure on the connection during the drying period.

### Heat Insulation

Wrap the flexible hose carefully with the attached heat insulation material from the start to the end (to indoor part)

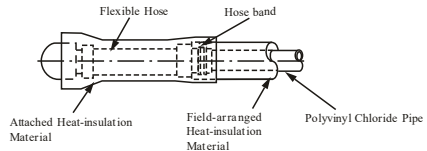

## HIGHT STATIC PRESSURE DRAINAGE PIPE INSTALLATION

Warning:

Must install drainpipes according to the following figure, avoiding generating condensed water and leakage water.

- Assemble the main body according to Figure.
- The opening of drainpipes can be installed on the left side or the right side. Could remove the drain stopper and put it on the left side or the right side.
- For the best effect, should keep pipes as short as possible. Tilt the pipes to ensure the flow of fluid.
- Make sure the drainpipes have admirable heat insulation.
- It is necessary to install a trap near the opening of the drainpipe, so that when the machine is working, the pressure in the inside of the machine is lower than atmospheric pressure. If there isn't an elbow, the water will splash and the pipe will produce a bad smell.
- Keep the straightness of drainpipes so as to remove dirt.
- Seal the drainpipe on the other side of the machine, then wrap up the drainpipe in the heat-barrier materials.
- Put water into the drain pan to test whether the water can be discharged swimmingly.
- In humid conditions, please must use an add-on drain pan (commercially available) to cover the whole area of the indoor unit.

# INDOOR UNIT INSTALLATION

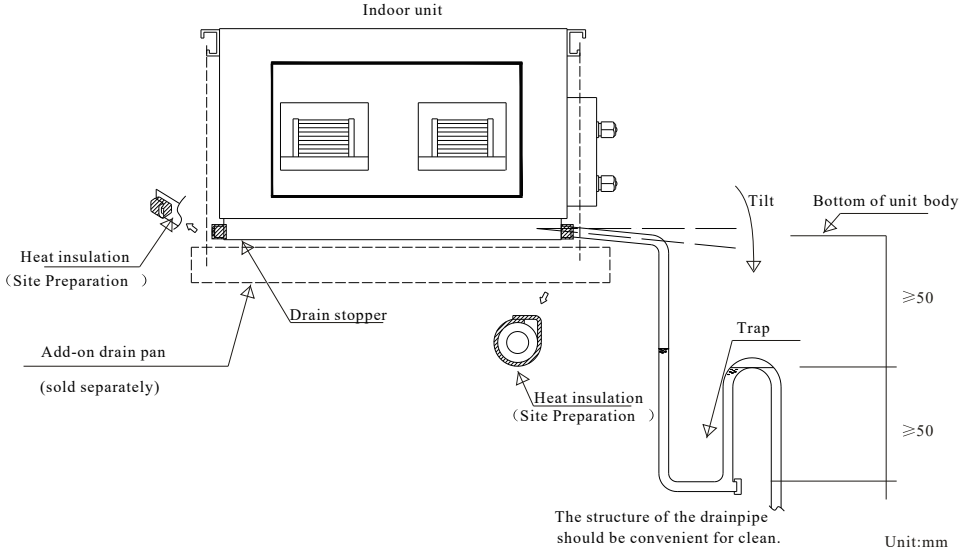

# INDOOR UNIT INSTALLATION

- Let the flare end of the copper pipe point at the screw and then tighten the screw by hand.
- After that, tighten the screw by the torque wrench unit it clatters (as shown in Fig).

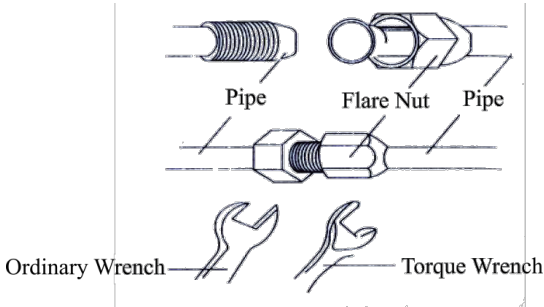

## JUNCTION FIXTURE

- Aim at connection pipe  
fix the nut of connection pipe, then tighten as the following diagram with spanner.

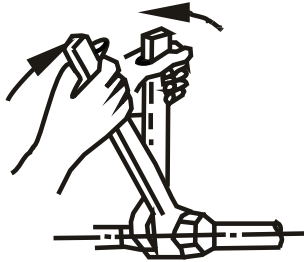

### ▲ Notice

- According to installation conditions, overlarge wrenched torch will destroy the nut. (Unit. N.cm)

### Torque Parameters

Pipe Size	Newton meter[N x m]	Pound-force foot(lbf-ft)	Kilogram-force meter(kgf-m)
1/4 " (φ 6.35)	15 - 20	11.1 - 14.8	1.5 - 2.0
3/8 " (φ 9.52)	31 - 35	22.9 - 25.8	3.2 - 3.6
1/2 " (φ 12)	45 - 50	33.2 - 36.9	4.6 - 5.1
5/8 " (φ 15.88)	60 - 65	44.3 - 48.0	6.1 - 6.6

# INDOOR UNIT INSTALLATION

1. Wiring method for indoor unit: Open the electric junction box to carry out wire connection. Notice that the connecting wire should be passed through wire-inlet rubber ring of the box. Connect the wires according to stipulations in the wiring diagram, and the wire splices at connecting terminal should be tightly compacted, free of looseness.

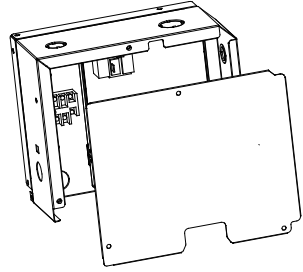

## 2. Binding treatment

Once the connecting wires have been properly connected, bind the connecting tubing, connecting wire and drain pipe by binding tapes.

After binding treatment, the cross section is shown in the figure below:

Notice: Drain pipe must not be flattened during binding treatment.

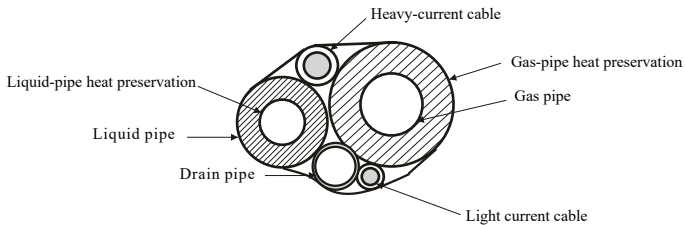

Drain pipe outlet should be led to a place that can avoid affecting the environment.

If situations as follow occur, please cut off the electric power before contacting the dealer.

- Open or close incorrectly.
- Fuse or electric leakage protector breaks for several times.
- Objects or water into the AC.

# INDOOR UNIT INSTALLATION

## 3.External wiring diagrams

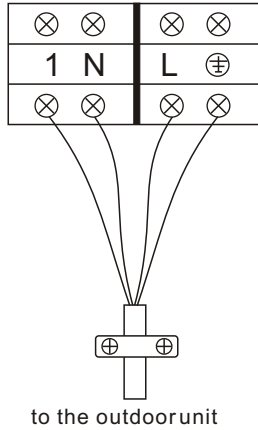

1-Signal line  
N-Null line  
L-Live line

## INDOOR UNIT

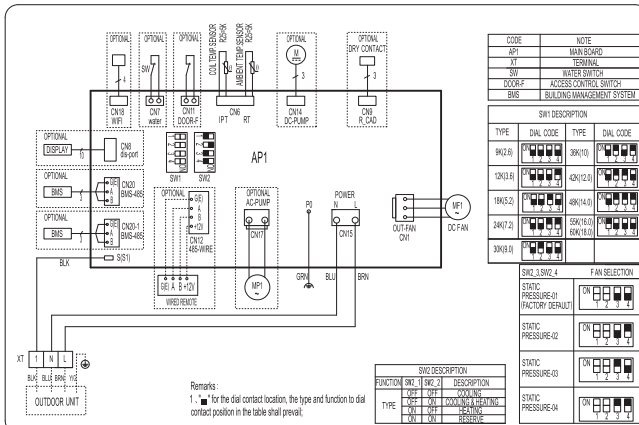

# OUTDOOR UNIT INSTALLATION

## Step1: Select Installation Location

Select a site that allows for the following:

- 1.1 Do not install the outdoor unit near sources of heat, steam or flammable gas.
- 1.2 Do not install the unit in too windy or dusty places.
- 1.3 Do not install the unit where people often pass. Select a place where the air discharge and operating sound will not disturb the neighbors.
- 1.4 Avoid installing the unit where it will be exposed to direct sunlight ( other wise use a protection, if necessary, that should not interfere with the air flow).
- 1.5 Reserve the spaces as shown in the picture for the air to circulate freely.
- 1.6 Install the outdoor unit in a safe and solid place.
- 1.7 If the outdoor unit is subject to vibration, place rubber blankets onto the feet of the unit.

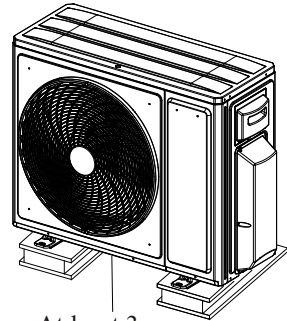
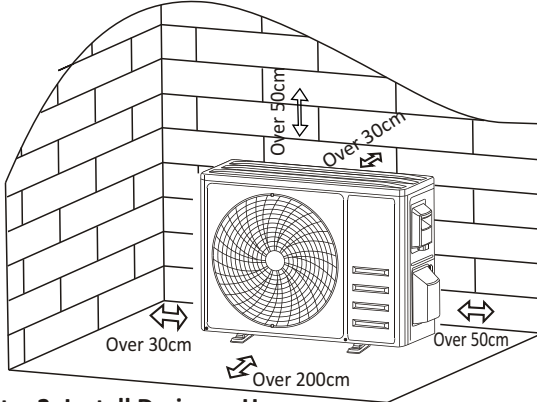

At least 3cm  
above the floor

## Step2: Install Drainage Hose

- 2.1 This step only for heating pump models.
- 2.2 Insert the drainage joint to the hole at the bottom of the outdoor unit.
- 2.3 Connect the drainage hose to the joint and make the connection well enough.

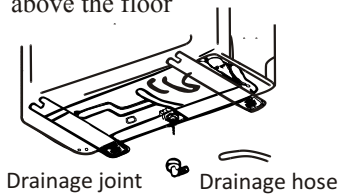

## Step3: Fix Outdoor Unit

- 3.1 According to the outdoor unit installation dimensions to mark the installation position for expansion bolts .
- 3.2 Drill holes and clean the concrete dust and place the bolts .
- 3.3 If applicable install 4 rubber blankets on the hole before place the outdoor unit (Optional).  
This will reduce vibrations and noise.
- 3.4 Place the outdoor unit base on the bolts and pre-drilled holes.
- 3.5 Use wrench to fix the outdoor unit firmly with bolts.

### Note:

The outdoor unit can be fixed on a wall-mounting bracket. Follow the instruction of the wall-mounting bracket to fix the wall-mounting bracket on the wall, and then fasten the outdoor unit on it and keep it horizontal. The wall-mounting bracket must be able to support at least 4 times of the weight of outdoor unit.

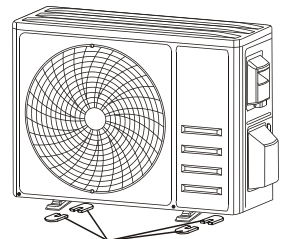

Install 4 rubber blankets (Optional)

# OUTDOOR UNIT INSTALLATION

## Step4: Install Wiring

- 4.1 Use a phillips screwdriver to unscrew wiring cover, grasp and press it down gently to take it down.
- 4.2 Unscrew the cable clamp and take it down.
- 4.3 According to the wiring diagram pasted inside the wiring cover, connect the connecting wires to the corresponding terminals, and ensure all connections are firmly and securely.
- 4.4 Reinstall the cable clamp and wiring cover.

**Note:** When connecting the wires of indoor and outdoor units, the power should be cut off.

## SINGLE MODELS

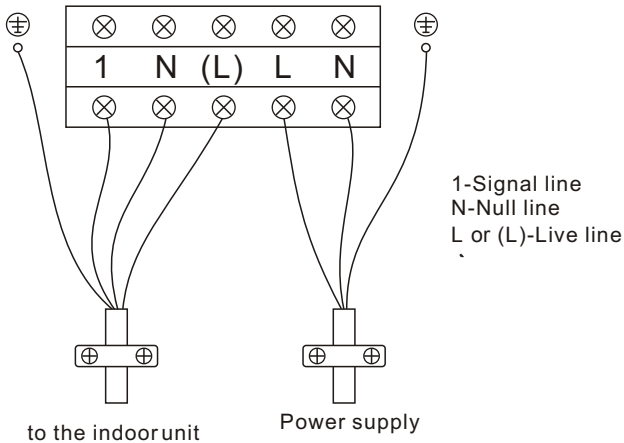
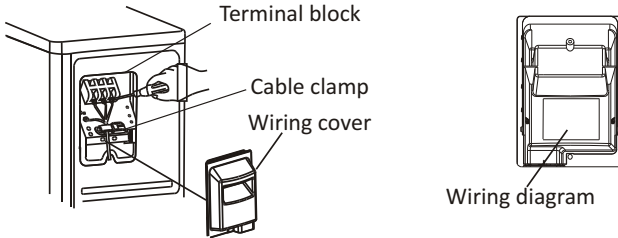

# OUTDOOR UNIT INSTALLATION

## Step4: Install Wiring

### MULTI MODELS

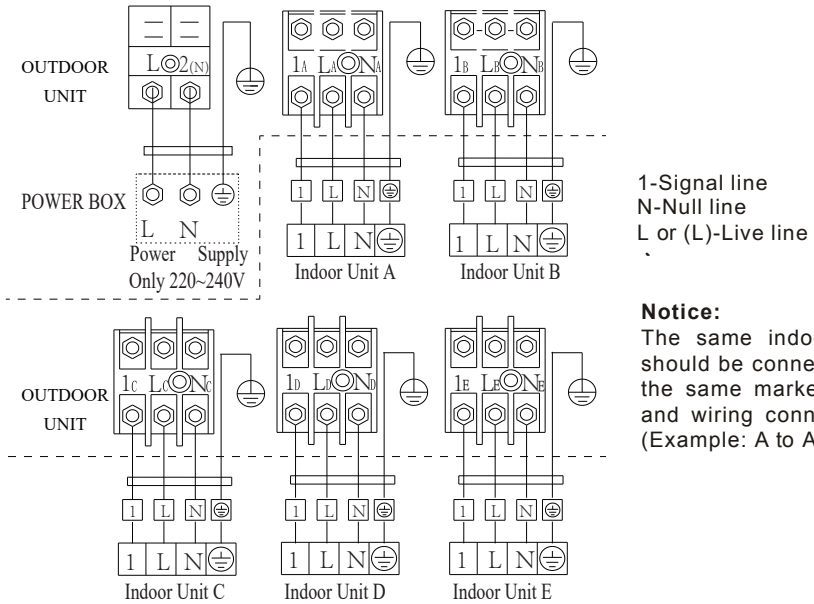
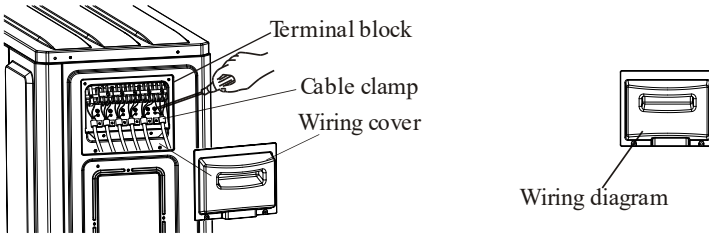

# OUTDOOR UNIT INSTALLATION

## Step5: Connecting Refrigerant Pipe

- 5.1 Unscrews the valve cover, grasp and press it down gently to take it down (if the valve cover is applicable).
- 5.2 Remove the protective caps from the end of valves.
- 5.3 Take off the plastic cover in the pipe ports and check whether there is any sundry on the port of the connecting pipe and make ensure the port is clean.
- 5.4 After align the center, rotate the flare nut of the connecting pipe to tighten the nut as tightly as possible by hand.
- 5.5 Use a spanner hold the body of the valve and use a torque wrench to tighten the flare nut according to the torque values in the torque requirements table.

(Refer to the torque requirements table on section **INSTALLATION PRECAUTIONS**)

### SINGLE MODELS

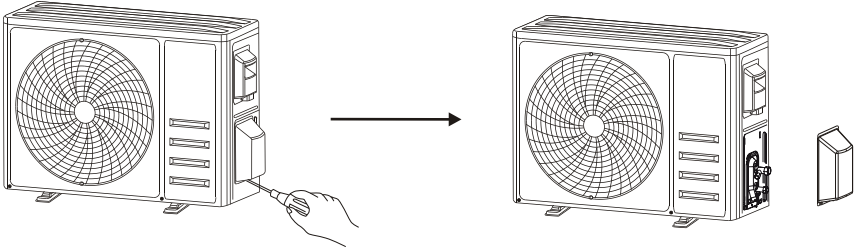

Take down the valve cover

connection pipes

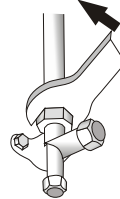
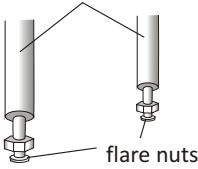

### MULTI MODELS

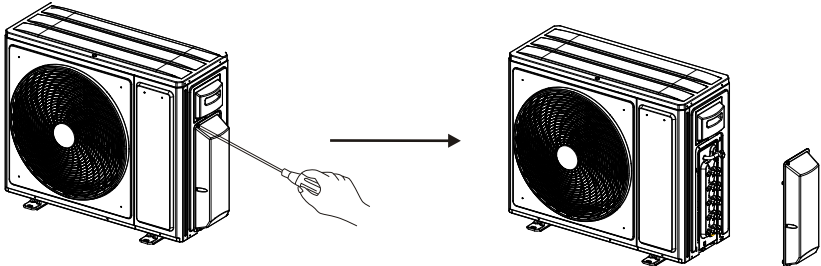

Take down the valve cover

connection pipes

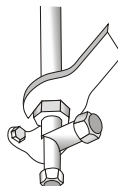
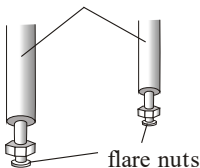

Take adapter for 1/2" or 5/8" connection pipe

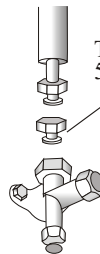

Optional for some indoor units

# TEST OPERATION

## Before testing

- a. Check if piping, drainage and external wiring have been finished correctly.
- b. Check if the power supply complies with requirements; if there is refrigerant leakage; if the all wires and cables are correctly connected and well fixed.

## ■ Function test

- a. After checking, energize your appliance and press the buttons on the control panel to see if the buttons function;
- b. If LCD screen displays normally.

## ■ Notes

1. Please read this operating and installation instructions carefully.
2. Do not let air in or refrigerant out during installing or reinstalling the appliance.
3. Test run the air conditioner after finishing installation and keep the record .
- 4.The air conditioner operates safely when ambient static pressure is 0.8~1.05 standard atmosphere pressure.

# CARE AND MAINTENANCE

## CLEANING

⚠ Warning: please shut down the unit and cut off the power before cleaning for safe.

### CLEAN THE FILTER

- Clean the unloaded filter with vacuum cleaner or water.
- Scrub with neutral detergent if the filter is too dirty. Do not wash with hot water (about above 50°C), in case it is out of shape.
- Place it on a ventilated place and cannot be under the sunshine directly after washing lest it is out of shape.
- For your purchasing unit is a rear ventilated one, please remove the filter fixed screws (2screws) and take down the filter a way from the unit.
- For your purchasing unit is a descensional ventilate done, please push the filter up slightly to let the position retainer escape away from the flange fixed holes, and take off the filter according to the arrow direction shows in the following fig.

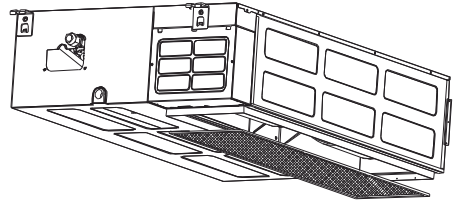
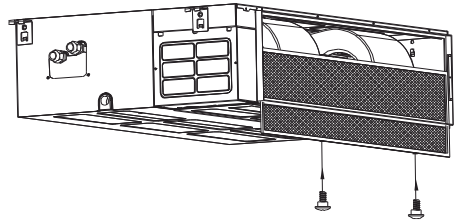

## MAINTENANCE

1. Please do the following job well if the air conditioner is not used for a long time.

In order to dry the unit completely, set the FAN mode and runs for 3-4hours.

Shut down the air conditioner and cut off the power supply.

2. When used again after the unit stops for a long period:

When cleaning the filter and indoor unit, you must stop the unit and cut off power supply. Wipe the indoor unit with soft cloth. It is forbidden to push the machine with petrol, benzene, lye, powder, detergent, insecticide etc., Which will damage the unit.

Ensure air in let and outlet of indoor and outdoor unit are not blocked by rubbish.

Check whether the grounded wire is loose and flexible, then connect the power.

## AFTER-SALESSERVICE

When your air conditioner can not run in order, please shut down the machine and cut off the power supply immediately. Then contact dealers.

# TROUBLESHOOTING

Error Code	Error Content
E0	Indoor and outdoor communication failure
E1	Indoor ambient temperature sensor failure
E2	Indoor fancoil temperature sensor failure
E3	Outdoor fancoil temperature sensor failure
E4	Abnormal system malfunction (lack of fluorine) <sup>5</sup>
E5	Model configuration error
E6	Indoor PG/DC fan failure
E7	Outdoor ambient temperature sensor failure
E8	Outdoor exhaust temperature sensor failure
E9	Outdoor IPM module failure/compressor drive failure
EA	Outdoor current sensor failure
Eb	PCB and display screen communication failure
EC	Outdoor modules Communication failure
EE	Outdoor EEPROM fault
EF	Outdoor DC fan failure
EH	Outdoor suction sensor failure
EP	Outdoor compressor casing top failure
EU	Outdoor voltage sensor failure
Ej	Outdoor central coil temperature sensor failure
En	Outdoor air pipe temperature sensor failure
Ey	Outdoor liquid pipe temperature sensor failure

Error Code	Error Content
P0	IPM module protection
P1	Overvoltage and undervoltage protection
P2	Overcurrent protection
P3	Other protections
P4	Protection against excessive outdoor exhaust temperature
P5	Cooling protection against overcooling
P6	Cooling and anti overheating protection
P7	Heating and anti overheating protection
P8	Protection against high or low outdoor temperature
P9	Compressor drive protection (abnormal load)
PA	Communication failure/mode conflict
F0	Infrared human sensing sensor failure
F1	Battery module failure
F2	Exhaust temperature sensor failure protection
F3	Failure protection of outer tube temperature sensor
F4	Abnormal protection of refrigerant circulation
F5	PFC protection
F6	Compressor missing/reverse phase protection
F7	Module temperature protection
F8	Abnormal commutation of four-way valve
F9	Module temperature sensor circuit malfunction

# TROUBLESHOOTING

Error Code	Error Content
FA	Compressor phase current detection fault
Fb	Cooling and heating overload protection limit frequency reduction
FC	High power protection limit/frequency reduction
FE	Module current (compressor phase current) protection limit/frequency reduction
FF	Module temperature protection limit/frequency reduction
FH	Drive protection limit/frequency reduction
FP	Anti condensation protection limit/frequency reduction
FU	Anti freezing protection limit/frequency reduction
Fj	Exhaust protection limit/frequency reduction
Fn	External AC current protection limit/frequency reduction

Error Code	Error Content
Fy	Fluorine deficiency protection
H1	High pressure switch malfunction
H2	Low pressure switch malfunction
bf	TVOC sensor failure
bc	PM2.5 sensor failure
bj	Humidity sensor failure
bE	CO2 sensor malfunction
bd	Fresh air fan failure
d4	Water full protection
d5	Access control protection

# TROUBLESHOOTING

MALFUNCTION	POSSIBLE CAUSES
The appliance does not operate	Power failour/plug pulled out.
	Damaged indoor/outdoor unit fan motor.
	Faulty compressor thermomagnetic circuit breaker.
	Faulty protective device or fuses.
	Loose connections or plug pulled out.
	It sometimes stops operating to protect the appliance.
	Voltage higher or lower than the voltage range.
	Active TIMER-ON function.
Damaged electronic control board.	
Strange odor	Dirty air filter.
Noise of running water	Back flow of liquid in the refrigerant circulation.
A fine mist comes from the air outlet	This occurs when the air in the room becomes very cold,for example in the “COOLING” or “DEHUMIDIFYING/DRY” modes.
A strange noise can be heard	This noise is made by the expansion or contraction of the front pane l due to variations in temperature and does not indicate a problem.
Insufficient airflow, eitherhot or cold	Unsuitable temperature setting.
	Obstructed air conditioner intakes and outlets.
	Dirty air filter.
	Fan an speed set at minimum.
	Other sources of heat in the room.
	No refrigerant
The appliance does not respond to commands	Remote control is not close enough to indoor unit
	The batteries of remote control need to be replaced.
	Obstacles between remote control and signal receiver in indoor unit
The display is opp	Active DISPLAY function.
	Power failure.
Switch off the air conditioner immediately and cut off the power supply in the event of :	Strange noises during operation.
	Faulty electronic control board.
	Faulty fuses or switches.
	Spraying water or objects inside the appliance.
	Overheated cables or plugs.
	Very strong smells coming from the appliance.

# DISPOSAL GUIDELINE

1. Minimum installation height, minimum room area (operating or storage) refer to installation manual.
2. Risk Of Fire-Auxiliary devices which may be ignition sources shall not be installed in the ductwork, other than auxiliary devices listed for use with the specific appliance. See instructions.
3. Mount with the lowest moving parts at least 2.5m (8ft) above floor or grade level.
4. Risk of electric shock. Can cause injury or death. Disconnect all remote electric power supplies before servicing.
5. Risk Of Fire. Flammable Refrigerant Used. To Be Repaired Only By Trained Service Personnel. Do Not Puncture Refrigerant Tubing.
6. Risk Of Fire. Dispose Of Properly In Accordance With Federal Or Local Regulations. Flammable Refrigerant Used.
7. Risk Of Fire. Flammable Refrigerant Used. Consult Repair Manual/Owner's Guide Before Attempting To Service This Product. All Safety Precautions Must Be Followed.
8. Risk Of Fire. Due to Flammable Refrigerant Used. Follow Handling Instructions Carefully in Compliance with National Regulations.

