

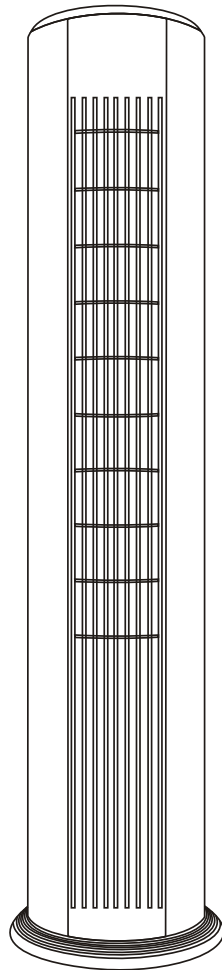

SPLIT AIR CONDITIONER FOR LIVING ROOM

R32

ASSEMBLY AND OPERATING MANUAL



Thank you for choosing our high-quality air conditioner. To ensure many years of satisfactory operation, please read this User Manual carefully before using your air conditioner. Keep it in a safe place after reading. Please refer to the user manual in case of any questions or irregularities regarding its use.

This air conditioner is for home use only.

REFRIGERANT R32

R32 refrigerants used in air conditioners belong to the environmentally friendly hydrocarbon class. Specifically, R32 refrigerant is a flammable gas that is odorless. It can also ignite and burst under certain undesirable conditions. However, despite all these possibilities, safe and easy use is ensured in indoor installations if the following safety and installation rules are followed.

Compared to other refrigerants, R32 is environmentally friendly, does not harm the ozone layer, and has a very low greenhouse gas impact, which has a significant effect on life.

The required installation areas for refrigerant R32 are:



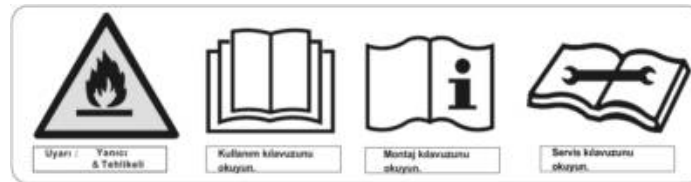















Refrigerant	Capacity (Btu/h)	Room Area
R32	9k	4 m ² and above
	12k	4 m ² and above
	18k	15 m ² and above
	22k/24k	25 m ² and above



WARNING (R32)

- Please read the maintenance, repair, and assembly manual beforehand.
- Note that R32 refrigerant is odorless.
- Please refer to the table above for the device's mounting location.
- Do not use any substances other than those recommended by the manufacturer during defrosting or heat exchanger cleaning of the appliance.
- Absolutely do not puncture the device, do not bring it near fire, and do not throw it into fire.
- Do not place your appliance in areas containing gas, liquid, or electrical appliances that are flammable and could cause high temperatures and fires.
- In case of a malfunction or when maintenance is required, please contact your nearest authorized service center. Service personnel must follow the manuals during repair or maintenance; Unauthorized persons are strictly prohibited from tampering with the device.
- The coolant must be drained during procedures such as scrapping the equipment or during maintenance.

SAFETY RULES AND RECOMMENDATIONS REGARDING INSTALLATION

<p> Please read this manual carefully and completely before you begin using the device.</p> <p> Ensure children cannot access the work area during the installation of both the indoor and outdoor units, and appropriately delineate this area. Unforeseen accidents can occur.</p> <p> Ensure the base of the outdoor unit is securely seated.</p> <p> Ensure no air can enter the cooling system and check for any refrigerant leaks after moving the air conditioner.</p> <p> After installing the air conditioner, run a test unit and note the results.</p> <p> A fuse with a rating of T 5A / 250V is used for this internal control unit.</p> <p> To protect the indoor unit, the user must install a fuse or similar overload protection device suitable for the maximum input current. should use.</p> <p> Ensure the mains voltage matches the voltage specified on the product label. Keep the switch or power plug clean. Insert the power plug correctly and properly into the socket to prevent electric shock or fire due to poor contact.</p> <p> Make sure the plug you are using is compatible with the socket; if not, change the socket.</p> <p> The device must be equipped with a device that will disconnect it from the mains connection by having a contact break at all poles and ensuring complete disconnection under overvoltage category III conditions. Such devices must consist of fixed cables in accordance with wiring regulations.</p> <p> All installation work for this air conditioner must be carried out by professionals or experts.</p>	<p> Place this device at least 50 cm away from flammable materials (eg, alcohol) or pressurized containers and tanks (eg, spray cans).</p> <p> If the appliance is installed in an area with inadequate ventilation, all necessary precautions must be taken to prevent refrigerant gas from leaking into the environment and creating a fire hazard.</p> <p> Packaging materials are recyclable and should be placed in appropriate waste bins. For end-of-life air conditioners, arrange for their delivery to a designated waste collection center.</p> <p> Use this air conditioner only according to the instructions in the user manual. These instructions are not intended to cover all possible situations and conditions. Therefore, as with other electrical household appliances, it is always recommended to exercise caution and supervision during installation, operation, and maintenance.</p> <p> This device must be installed in accordance with all applicable national regulations.</p> <p> Before working on the product, ensure all electrical connections are disconnected.</p> <p> This device must be installed in accordance with all applicable national cable placement regulations.</p> <p> This device may be used by children over the age of 8 and by persons with partial physical disabilities but intellectual capacity, provided they are given information about its safe use and understand the risks involved. Children should not play with the device. Cleaning and maintenance should not be performed by children unless supervised.</p>
--	--

SAFETY RULES AND RECOMMENDATIONS FOR USE

<p>⚠ Never attempt to install an air conditioner on your own. Always seek assistance from a qualified technician.</p> <p>⚠ Cleaning and maintenance work should only be performed by qualified technical personnel. Always disconnect the mains power supply before performing any cleaning or maintenance work. Ensure that the mains voltage matches the voltage specified on the product label. Keep the circuit breaker or power plug clean and dry. Insert the power plug correctly and properly to prevent electric shock or fire due to poor contact.</p> <p>⚠ Do not unplug the device while it is running; otherwise, it may create a spark and cause a fire.</p> <p>⚠ This appliance is designed for climate control in home environments and should not be used for any other purpose, such as drying clothes or cooling food.</p> <p>⚠ Do not use this device without an air filter. Using the air conditioner without an air filter can cause excessive dust or debris to accumulate inside the device, leading to malfunctions.</p> <p>⚠ The user is responsible for ensuring that the device is installed by a qualified technician. This technician must verify that the device is properly grounded in accordance with applicable regulations and connect a circuit breaker (fuse) to the circuit.</p> <p>⚠ The batteries inside the remote control should be recycled or disposed of properly. Please dispose of used batteries properly. Deliver your waste to the designated collection points determined by the municipalities.</p>	<p>⚠ Avoid prolonged exposure to cold air. Direct and prolonged exposure to cold air can lead to health problems.</p> <p>Particular attention should be paid to this situation in rooms where children, the elderly, or the sick are present.</p> <p>⚠ If you notice smoke or a burning smell coming from the appliance, immediately disconnect the power supply and contact an authorized service center.</p> <p>⚠ Prolonged use of the device in such environments may result in fire or electric shock.</p> <p>⚠ For repairs, contact only an Authorized Service Center designated by the manufacturer. Incorrect repairs can result in dangerous situations such as electric shock.</p> <p>⚠ If you will not be using the device for an extended period, switch the V automatic switch to the off position. The airflow direction must be properly adjusted.</p> <p>⚠ The indoor unit's air vents move downwards in heating mode and upwards in cooling mode. It should be positioned.</p>
--	--

SAFETY RULES AND RECOMMENDATIONS FOR USE

- | | |
|---|--|
| <ul style="list-style-type: none">⊖ To avoid damaging the electrical cord, do not twist, pull, or pinch it. A damaged electrical cord can cause electric shock or fire. Damaged electrical cords should only be replaced by a qualified technician.
⊖ Do not use extension cords or similar materials.
⊖ Do not touch the device barefoot or with any part of your body wet or damp.
⊖ Do not obstruct the air intake or exhaust of the indoor and outdoor units. Blocking these intake and exhaust sections will reduce the efficiency of the air conditioner, resulting in malfunctions or damage.
⊖ Under no circumstances should you modify the device's settings.
⊖ Do not use the device in environments containing oil and sulfur in the air, or near heat sources.
⊖ This device is not intended for use by persons with partial physical or mental disabilities (including children). However, it may be used by such persons provided that a person responsible for their safety provides Instructions or supervises the use of the device. | <ul style="list-style-type: none">⊖ Do not climb on the device or place heavy or hot objects on it.

⊖ Do not leave windows or doors open for extended periods while the air conditioner is running.
⊖ Do not direct the airflow towards plants or animals.
⊖ Exposing plants and animals directly to cold air currents for extended periods can have adverse effects.

⊖ Do not allow the air conditioner to come into contact with water. This could damage the electrical insulation and cause electric shock.
⊖ Do not climb on the device or place objects on the outdoor unit.
⊖ Do not insert any sticks or similar objects into the device. Otherwise, injury may occur.

⊖ Children should be supervised to ensure they do not play with the appliance. If the power cord is damaged, it should be repaired by the manufacturer, service representative, or similarly qualified person to prevent any danger. It should be changed. |
|---|--|

TRACK NAMES

INDOOR UNIT	
No.	Describing
1	Front panel
2	Air outlet
3	Control Panel
4	Opening door
5	Filter
6	Air intake
7	Remote control

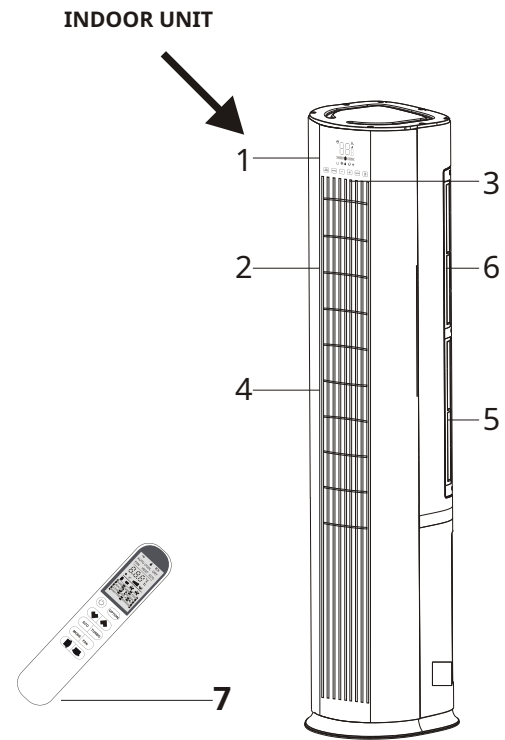

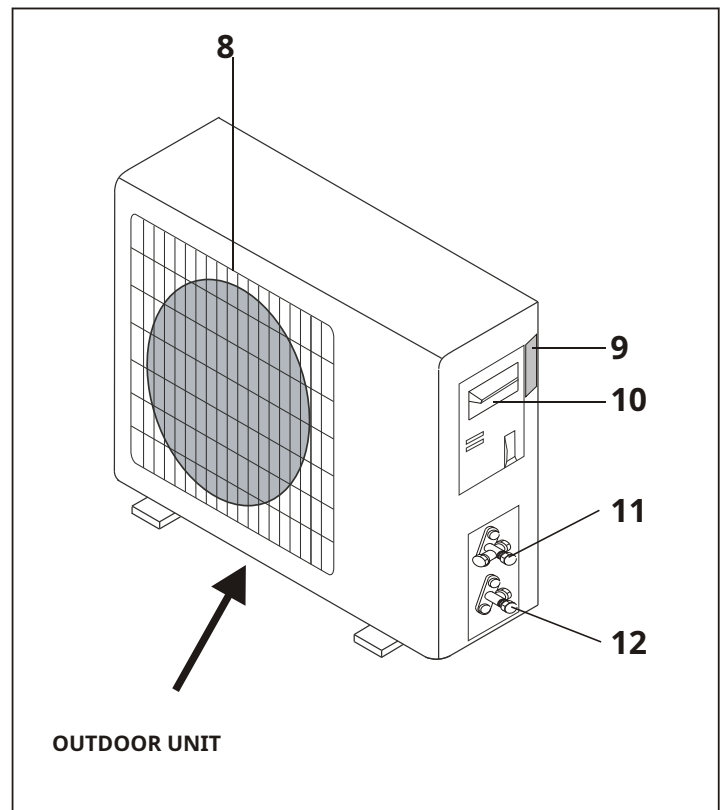

OUTDOOR UNIT	
No.	Describing
8	Air outlet grille
9	Outdoor unit label
10	Terminal block cover
11	Gas valve
12	Liquid valve





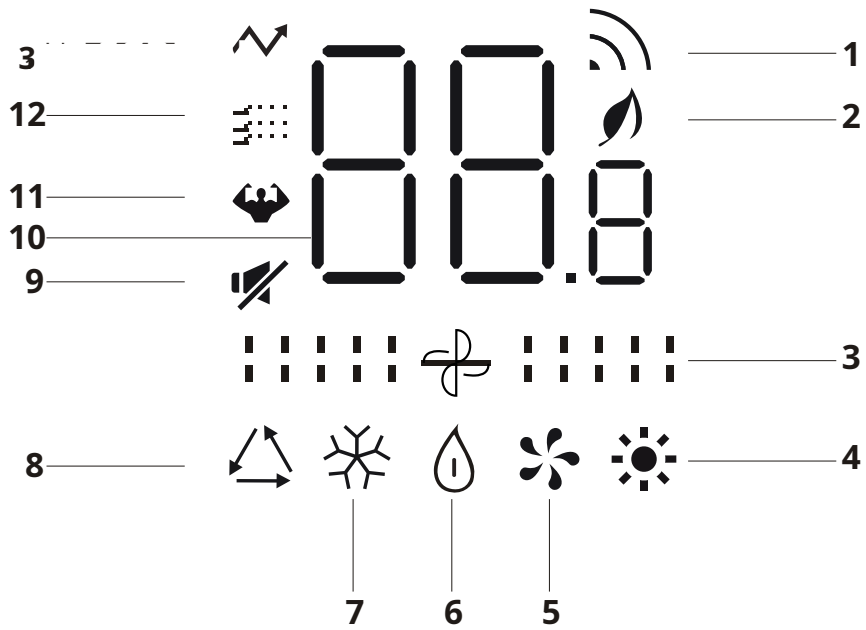









 *Note: The images above are for reference only and the actual unit may look different.*







INDOOR UNIT SCREEN



 Note: The images above are for reference only and the actual unit may look different.

No.	LED	Function
1		WIFI
2		HEALTH
3		FAN SPEED
4		The HEATING light switches on during defrost and cold air blow-off protection.
5		Fan-only operation
6		DEHUMIDIFICATION
7		COOLING
8		FEEL mode operation
9		SILENT mode
10		Set temperature value unit: °C or F °
11		TURBO
12		Windless mode
13		Electric heater

Indoor Unit Control Panel

	Keys	function
	SWING	Adjust the blowing direction to the left and right.
	FAN SPEED	Adjusting the fan speed
	TEMP+	Temperature increases in 0.5°C increments.
	TEMP-	Temperature increase in 0.5C
	MODE	increments Select operating mode.
	ON/OFF	Turning the air conditioner on and off.

 *The shape and location of the emergency button may vary depending on the model, but its functions are the same.*

Warning: The external static pressure is 0 Pa for all models.

REMOTE CONTROL

No.	Keys	Function
1		Turning the air conditioner on and off.
2	OPTION	Enabling or disabling optional features.
3	∨	To lower the temperature, set a timer or select a function.
4	∧	To increase the temperature, set the timer or select the function.
5	ECO	Enabling/disabling the ECO function saves energy for the unit. It automatically adjusts its operation to provide this.
6	TURBO	Enabling/disabling the super function activates the unit's preset settings. enabling it to reach the temperature as quickly as possible
7	MODE	To select the operating mode (AUTOMATIC COOLING DEHUMIDIFICATION HEATING)
8	FAN	Use this to select automatic/silent/low/medium/medium/high/high/turbo fan speeds. Flashing
9		1. To enable (left/right) or disable the vertical flap swing if the impact time interval is longer than 2 seconds. 2. If the time interval is within 2 seconds, the rotation angle range of the vertical flap will be a cycle. deactivated
10		1. Activate horizontal oscillation if the time interval is longer than 2 seconds. (left/right) or to disable. 2. If the time interval is 2 seconds, the angle range of the horizontal oscillation (left/right) It will rotate as shown. Flashing deactivated

ON/OFF	MOD	FEATURES
ON	AUTO	TIMING DISPLAY HEALTH FEEL
	COOL	Timing Display Health Sleep Mold Protection feel
	DRY	TIMING DISPLAY HEALTH MOLD PROTECTION FEEL
	FAN	TIMING DISPLAY HEALTH FEEL
	HEAT	TIMING DISPLAY HEALTH SLEEP FEEL 8CH °
OFF	AUTO	TIMING CLEAN SCREEN HEALTH FEEL
	COOL	Timing, Clear Screen, Health, Sleep, Mold Protection, Feeling.
	DRY	Timing, Clear Screen, Health, Mold Protection, Feeling.
	FAN	TIMING CLEAN SCREEN HEALTH FEEL
	HEAT	TIMING CLEAN SCREEN HEALTH SLEEP I FEEL8 CH °

You will hear a beep when you press the buttons below or select the optional functions below, but the actual model may not have this function:

(Optional: COMFORT COOLING air blowing)

(Optional: COMFORT HEATING air blowing)

HEALTH (Optional: ionizer operation)

(Key: WING RIGHT/LEFT)

REMOTE CONTROL

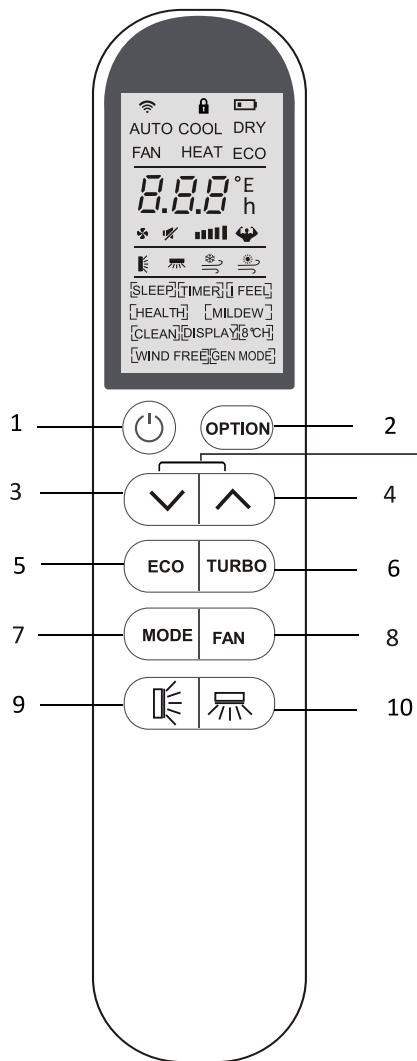

When the keys are pressed for longer than 3 seconds
The lock is activated or deactivated.

 You will hear a beep when you press the buttons below or select the optional functions below, but the actual model may not have this function:

 (Optional: COMFORT COOLING air blowing)

 (Optional: COMFORT HEATING air blowing)











HEALTH (Optional: ionizer operation)

 (Key: WING RIGHT/LEFT)

REMOTE CONTROL

Remote Control Display

The meaning of symbols in liquid crystal display.

No.	Symbol	Explanation
1		WIFI
2		Lock function indicator
3		Battery Indicator
4	AUTO	Automatic mode indicator
5	COOL	Cooling mode
6	DRY	Dehumidification
7	FAN	Fan mode
8	HEAT	Heating mode
9	ECO	ECO mode
10	23.5 h [TIMER]	Timer indicator
11	28.5 °C	Temperature Indicator
12		Fan speed: auto, low, medium, high
13		Silent mode indicator
14		Turbo comfort mode indicator
15		Blower vane angle indicator
16		Horizontal wing angle indicator
17		Comfortable cooling airflow indicator.
18		Comfortable heating airflow indicator.
19	<p>[SLEEP] [TIMER] [I FEEL]</p> <p>[HEALTH] [MOLD PROTECTION]</p> <p>[CLEAN] [CLEAN] [8°C]</p> <p>[WINDLESS] [GEN MODE]</p>	<p>Optional features indicator</p> <p> <i>Note: Some models do not have HEALTH, WINDLESS, and GEN MOD features.</i></p>



The angles shown in the models below cannot be selected.



REMOTE CONTROL

Battery Replacement

Remove the cover located on the back of the remote control by sliding it in the direction shown.

Slide the battery cover back onto its place.

Use 2 pieces LRO 3 (1.5V) battery. Do not use rechargeable batteries.

Do not dispose of used batteries with household waste.

Dispose of this type of waste properly, according to specific instructions.

⚠ See Figure 1:

When you remove the battery cover, you can see the DIP switch on the back of the cover.

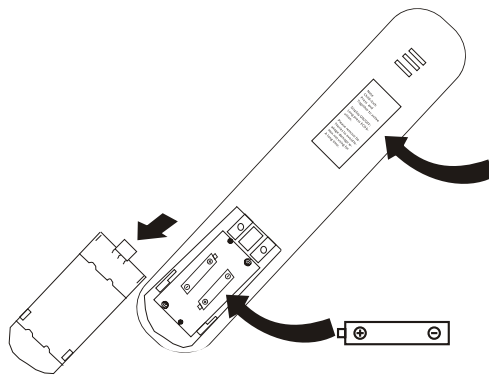

Note:

For child lock ∨ ∧ Press the key simultaneously

ON/OFF: Press and hold the ECO button.

Please remove the batteries when not in use to prevent leakage and damage.



1. Hold the remote control straight towards the air conditioner.
2. Ensure there are no obstructions between the remote control and the signal receiver on the indoor unit.
3. Never expose the remote control to direct sunlight.
4. Keep the remote control at least 1 meter away from the television and other electrical appliances.

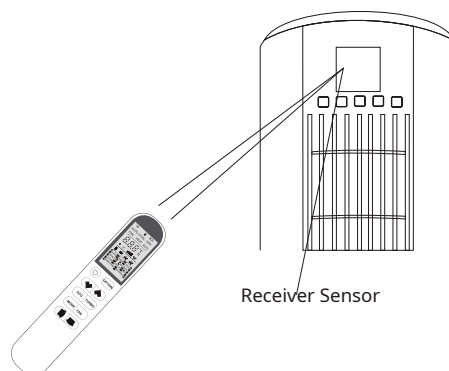

INSTRUCTIONS FOR USE

Air drawn in by fans through the grille is passed through filters and then cooled/dehumidified or heated via a heat exchanger.

The direction of the airflow is controlled up and down by the vanes, and manually moved left and right by the vertical air deflector vane. In some models, the air deflector vanes can also be adjusted electrically.

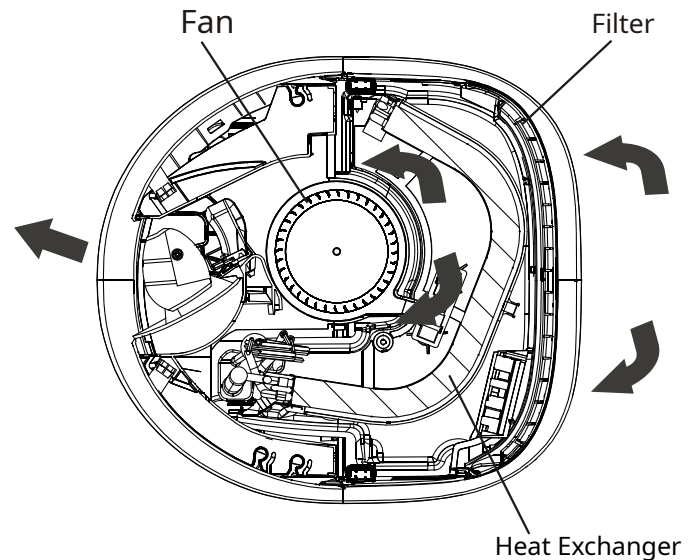

AIR EMISSION CONTROL

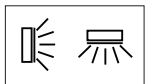

- Airflow is evenly distributed throughout the room.
- It was possible to position the direction of the air in the optimum way.

- Key Activates the FLAP, airflow Alternatively, it is directed from top to bottom. To ensure that the air in that area is distributed evenly.

- Key motor powered It activates the deflectors. airflow alternative from left to right. It is directed. (Optional function, depends on the models)

When cooling wood, direct the fins horizontally; when heating wood, direct the fins downwards, as hot air tends to rise.

The reflectors are positioned manually and They are placed under the wings. They allow airflow to be directed to the right or left.

Ensure the unit is not operating in this configuration.

Do not manually reposition the flaps, otherwise they may be damaged.

Do not insert your fingers or other objects into the air intake or exhaust openings. This could cause an accident.

The angles shown in the models below cannot be selected.

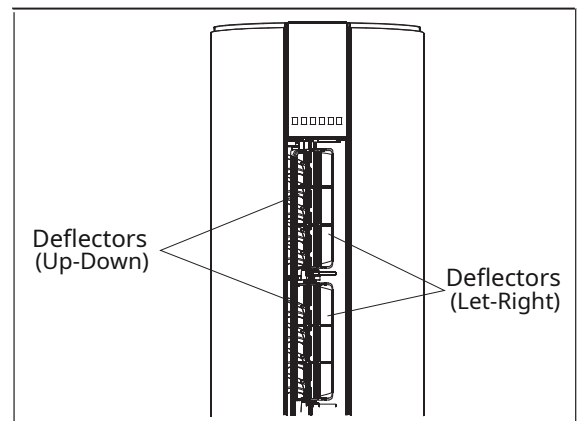
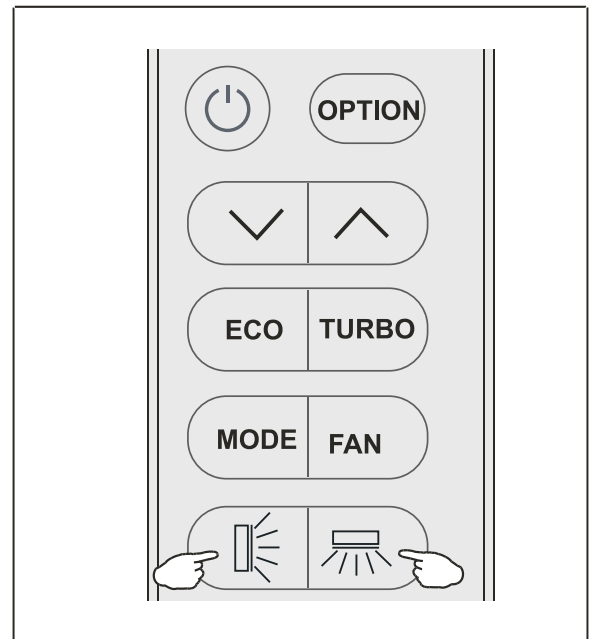

INSTRUCTIONS FOR USE

COOLING MODE

Cool

By using the cooling function, you can both lower the room temperature and reduce the humidity level.

To activate the cooling function (COOL), press the MODE button and the COOL symbol will appear on the screen.

To activate the cooling function, or  

Set the temperature to a lower temperature than the room temperature using the button. To optimize the air conditioning functions, change the temperature (1), speed (2) and airflow direction (3) by pressing the corresponding button.

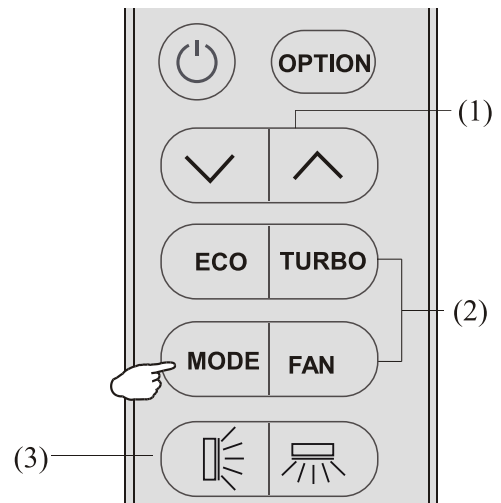

HEATING MODE

HEAT

By using the heating function, you can both raise the room temperature and reduce the humidity level.

To activate the heating function (HEAT), press the MODE button and the HEAT symbol will appear on the screen.

To activate the heating function, or  

Set the temperature to a higher temperature than the room temperature using the button. To optimize the air conditioning functions, change the temperature (1), speed (2) and airflow direction (3) by pressing the corresponding button.

 While in HEATING mode, the device can initiate an automatic defrost cycle to melt the ice accumulated in the condenser, thus enabling the heat exchange function. During the defrosting process, the indoor unit fan stops, and this process usually takes 2-10 minutes. After the defrosting process, HEATING mode is automatically restarted.

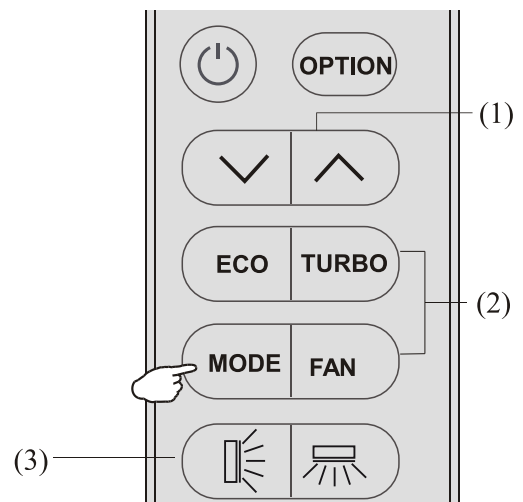

DEHUMIDIFICATION MODE

DRY

This function reduces humidity in the room to increase comfort.

To set the dehumidification mode, press and hold the MODE button until DRY appears on the screen. This automatically switches between cooling cycles and the air fan.

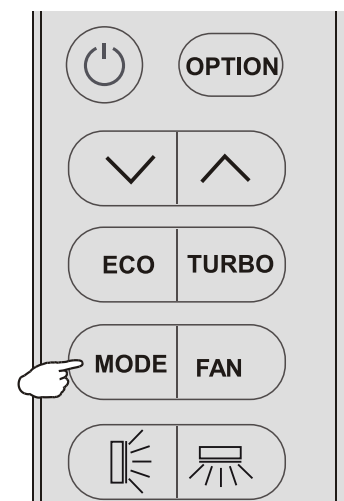

INSTRUCTIONS FOR USE

FAN MODE

FAN

The air conditioner only works in ventilation mode.

To set FAN mode, press and hold the MODE button until FAN appears on the screen.

When you press the FAN button, the speed settings are changed in the following order: Low/Medium/High/Auto

In addition to all this, the remote control also memorizes the speed from the previous use.

AUTOMATIC OPERATION MODE

AUTO

Automatic comfort operation

To activate AUTOMATIC operating mode, press the MODE button on the remote control until the AUTO symbol appears on the screen.

In AUTOMATIC mode, the fan speed and temperature are automatically adjusted according to the room temperature (tested by the temperature sensor located in the indoor unit).

Ambient temp	Operation mode	Auto temp.
< 20°C	HEATING (FOR HEAT PUMP TYPE) FAN (FOR COOL ONLY TYPE)	23°C
20°C~26°C	DRY	18°C
> 26°C	COOL	23°C

To optimize the air conditioner's function, adjust the temperature (1), speed (2) and airflow direction (3) by pressing the indicated buttons.

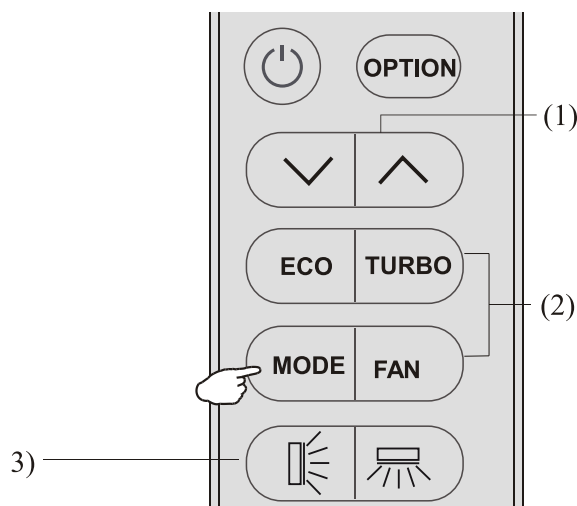

PANEL SCREEN

DISPLAY

Turning the LED display on the panel on or off.

Press the OPTION button and keep pressing until DISPLAY appears on the screen.

^ Press the or keys; Press the OPTION button again to turn off the LED display on the panel. on the remote control **DISPLAY** visible.

Repeat the process to see the LED screen.

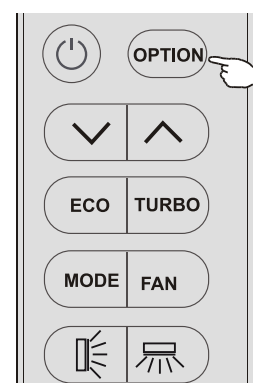

INSTRUCTIONS FOR USE

ECO MODE

ECO

The air conditioner is in energy-saving operating mode.

The ECO symbol only appears on the display when in heating or cooling mode. The air conditioner is operating in energy-saving mode.

To cancel this operating mode, press the MODE button and then press the ECO button again.

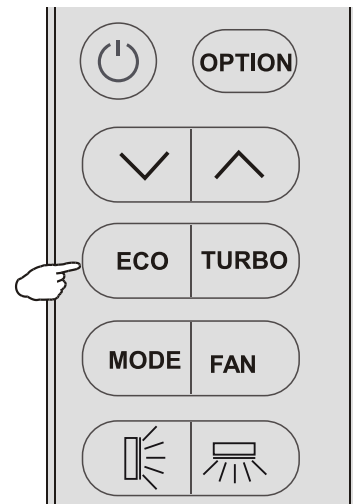

TURBO FAST COMFORT MODE



To activate TURBO operating mode, press the FAN button until the symbol appears on the screen.



To cancel this function, press the FAN or TURBO button again to change the fan speed.

In AUTOMATIC / HEATING / COOLING / FAN mode, selecting the TURBO feature uses the highest fan setting for a powerful airflow.

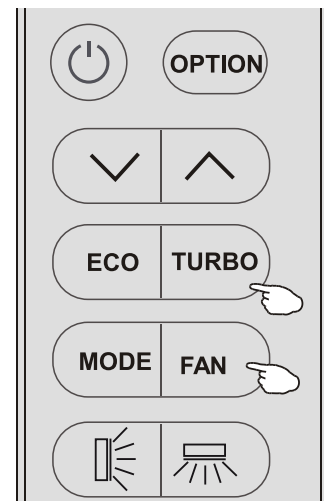

SLEEP MODE

SLEEP

To activate SLEEP mode, press SLEEP on the screen. Keep pressing the OPTION button on the remote control until the symbol appears.

The SLEEP function adjusts the temperature to enhance comfort in the room during nighttime hours. Cooling

Or, when in dehumidification mode, the set temperature is automatically reduced to 1 every 60 minutes. The temperature is increased by 2 degrees. Thus, 2 hours after the air conditioner starts working, the temperature will be 2 degrees increased.

In heating mode, the set temperature will gradually increase 2 hours after the air conditioner starts operating.

The rank is lowered.

The air conditioner automatically switches off after 10 hours of operation in sleep mode.

It closes like that.

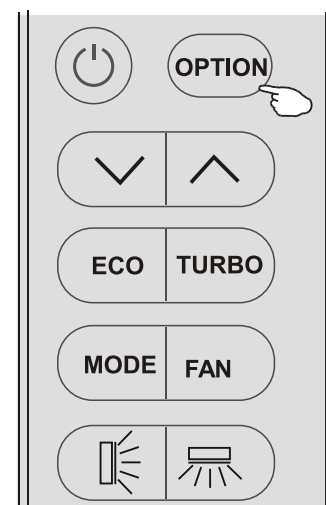

INSTRUCTIONS FOR USE

TIMER MODE



For automatically turning the air conditioner on and off.

To start the timer, before proceeding with the timer: Turn off the air conditioner using the power button. Program the operating mode using the MODE button and the fan speed using the FAN button.

Timer setting / change / cancel:

1. Press the OPTION button for the first time until the TIMER symbol flashes, or select TIMER by pressing the button; 2. Press the OPTION button again, and the Timer symbol will flash 6.0 h

3. To set or change the timer:

(1) Press the or key to set the desired time (increase or decrease in half-hour increments) while h and TIMER are flashing.

(2) To confirm the timer, press the OPTION button without doing anything or wait 5 seconds. The preset time will appear on the screen, such as the symbol. To delete the timer (if TIMER is on), press the OPTION button without doing anything or wait 5 seconds.

4. Figure 1 Timer on, Figure 2 Timer off

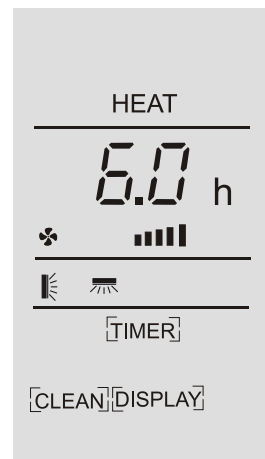
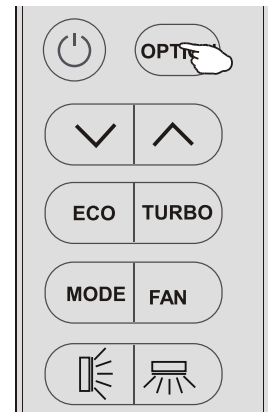

Figure 1

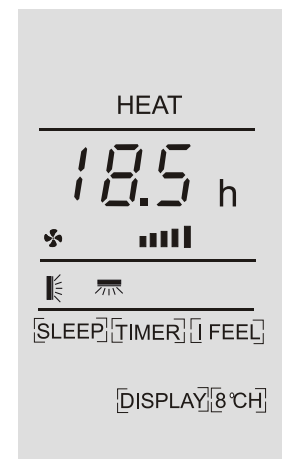

Figure 2

Note: All transactions must be completed within 5 seconds, otherwise they will be cancelled.

I FEEL MODE



To activate I FEEL (comfort) mode, press the remote until the I FEEL symbol appears.

Keep pressing the button on the remote control.

I FEEL In this mode, both fan speed and temperature settings are adjusted.

It automatically adjusts according to room temperature. Measured via the remote control, it sends a signal to the indoor unit 7 times in 2 hours to create the most comfortable environment.

This operating mode will continue for 2 hours or until the desired room temperature is reached.

0~50°C It will be canceled if the temperature exceeds the limit.

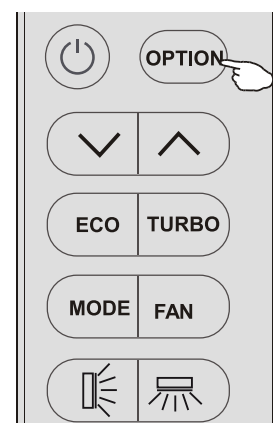

INSTRUCTIONS FOR USE

MOLD PROTECTION

[MILDEW]

Press the OPTION button until the MILDEW symbol flashes, and then press the down button to select MILDEW; MILDEW

To activate the function, press the OPTION button again and it will appear on the screen. [MILDEW] appears.

To disable this function, do it again.

This function ensures that even when the air conditioner is switched off, it still provides approximately 15 minutes of airflow to dry the internal components of the air conditioner, thus preventing mold growth.

Note: This function is only valid in DEHUMIDIFICATION/COOLING mode.

SELF-CLEANING

[CLEAN]

Turn off the air conditioner by pressing the OPTION button.

Select CLEAN until the CLEAN symbol flashes; by pressing the OPTION button again to activate the CLEAN function. [CLEAN] It appears on the screen.

To disable this function, do it again.

1. This function removes bacteria and dirt from the evaporator.
2. This function resets after 30 minutes. The function can be canceled by pressing the Mode button or the Power button.

Two beeps will be heard when the function is complete.

3. Any noise that may occur during the operation are due to the expansion and cooling of the internal materials.

4. The transaction is suitable under the following conditions.

Indoor unit	heat <30°C
Outdoor unit	5°C < heat <30°C

5. It is recommended that this study be conducted every 3 months.

8°C Heating Feature

[8°C H]

It can only be used while heated.

1. Press the OPTION button until 8°C H symbol flashes. And by pressing the button [8°C H]

Please make your choice; 8°C H To enable the function, use OPTION Press the button again.

To disable this function, do it again.

2. Even if the air conditioner is off, once this feature is activated, the device will start heating if the ambient temperature is lower than or equal to 18°C. The process will stop once the room temperature is higher than or equal to 18°C.

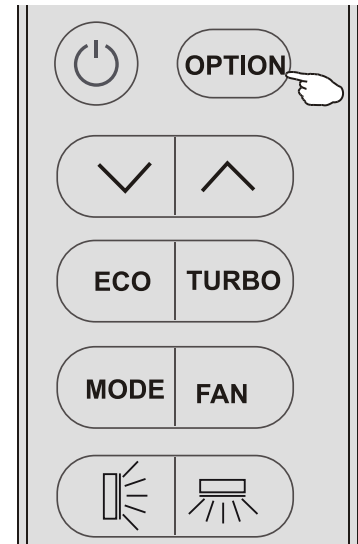

Operating Temperature

The air conditioner is programmed for comfortable and suitable living conditions, as described below; if used outside of these conditions, certain safety protection features may be activated.

Constant speed air conditioner:

Heat / MODE	Cooling	Heating	Dehumidification
Room temperature	17°C ~32°C	0°C ~27°C	18°C~32°C
Outside Air Temperature	0°C ~43°C For T1 climate	-7°C~24°C	0°C~50°C
	0°C ~52°C For T3 climate		

Inverter air conditioner:

Heat / MODE	Cooling	Heating	Dehumidification
Room temperature	17°C ~32°C	0°C ~30°C	10°C~32°C
Outside Air Temperature	0°C ~53°C	-15°C~30°C	0°C~50°C
	-15°C ~53°C for models that can cool at low temperatures		



The unit will not start immediately after being switched off or switched on again after maintenance. This is a normal self-protection action; you should wait approximately 3 minutes.



Capacity and efficiency testing is performed while the indoor unit fan motor is operating at full load at its highest speed, with the flaps and deflectors at their maximum airflow angle.

Important Considerations:

- The air conditioner you purchased must be installed by professional personnel, and the "installation manual" is for professional use only! Installation specifications must comply with after-sales service regulations.
- When handling flammable coolant, any of your rough operations could cause serious injury or harm to the human body or the object.
- A leak test should be performed after the installation is complete.
- To ensure the risk of fire is minimized, it is essential to perform a safety check before servicing or repairing an air conditioner using flammable refrigerant.
- To minimize any risk from flammable gases or vapors during operation, the machine must be operated using a controlled procedure.
- The total weight of the filled refrigerant and the requirements for a room area equipped with air conditioning are shown in Tables GG.1 and GG.2 below.



ASSEMBLY INSTRUCTIONS ---- Important warnings

Maximum refrigerant volume and minimum area values:

$$m_1 = (4 \text{ m}^3) \times \text{LFL}, \quad m_2 = (26 \text{ m}^3) \times \text{LFL}, \quad m_3 = (130 \text{ m}^3) \times \text{LFL}$$

If LFL has a low flammability limit, then kg/m³, R290 LFL is 0.038 kg/m³, R32 LFL is 0.306 kg/m³

Charge level for devices $m_1 < M \leq m_2$:

$$\text{room}; \quad m_{\max} = 2.5 \times (\text{LFL})^{(5/4)} \times h_0 \times (A)^{1/2}$$

$$\text{Amount of refrigerant required for installation in M (kg) for the minimum required space;} \quad A_{\min} = (M / (2.5 \times (\text{LFL})^{(5/4)} \times h_0))^2$$

Symbols;

m_{\max} Maximum accepted refrigerant quantity (kg)

M Amount of refrigerant to be placed in the device

(kg) Minimum required area (m²)²

A room area m²

LFL minimum flammability limit value kg/m³

h_0 The mounting height of the device is calculated for wall type. m_{\max} or A_{\min} 1.8m

Table GG.1 - Maximum charge amount (kg)

Category	LFL (kg/m ³)	h_0 (m)	Local area (m ²)						
			4	7	10	15	20	30	50
R290	0.038	0.6	0.05	0.07	0.08	0.1	0.11	0.14	0.18
		1	0.08	0.11	0.13	0.16	0.19	0.2	0.3
		1.8	0.15	0.2	0.24	0.29	0.34	0.41	0.53
		2.2	0.18	0.24	0.29	0.36	0.41	0.51	0.65
R32	0.306	0.6	0.68	0.9	1.08	1.32	1.53	1.87	2.41
		1	1.14	1.51	1.8	2.2	2.54	3.12	4.02
		1.8	2.05	2.71	3.24	3.97	4.58	5.61	7.254
		2.2	2.5	3.31	3.96	4.85	5.6	6.86	8.85

Table GG.2 - Minimum room area (m²)²

Category	LFL (kg/m ³)	h_0 (m)	Charge level (M (kg))						
			Minimum room space (m ²)						
R290	0.038		0.152kg	0.228 kg	0.304 kg	0.456 kg	0.608 kg	0.76 kg	0.988 kg
		0.6		82	146	328	584	912	1514
		1		30	53	118	210	328	555
		1.8		9	16	36	65	101	171
		2.2		6	11	24	43	68	115
R32	0.306		1.224 kg	1.836 kg	2.448 kg	3.672 kg	4.896 kg	6.12 kg	7.956 kg
		0.6		29	51	116	206	321	543
		1		10	19	42	74	116	196
		1.8		3	6	13	23	36	60
		2.2		2	4	9	15	24	40

ASSEMBLY GUIDE - Important points to note.

Assembly Safety Principles

1. Environmental Security



Places where the use of flames is prohibited

Areas with airflow

2. Workplace Safety



Static Electricity Protection

Protective Clothing and Anti-static Gloves

Do not use your cell phone.

3. Assembly Safety

Gas leak detector



Suitable mounting area

Please Note:

- 1- The installation area must have good airflow (ventilation).
- 2- The installation area must be free of smoke and high temperatures. R290 refrigerant poses a danger at 370°C, and R32 refrigerant at 548°C. Smoking, welding, and proximity to ovens and similar appliances are prohibited. Anti-static clothing and gloves must be worn during air conditioner installation or maintenance.
- 3- During installation, maintenance, or operation, the air inlets and outlets of the indoor and outdoor units must not be obstructed and must not be near any heat source. The area must be away from heat sources and flammable/explosive environments.
- 4- If a gas leak is detected during installation or maintenance, immediately close the outdoor unit valves and leave the area for at least 25 minutes. If the product is damaged (pipe breakage, valve malfunction, etc.), it must be repaired by an Authorized Service Center. Only this specific fault will be fixed, and the product installation will continue without any further work.
- 5- A location should be chosen where the indoor and outdoor units can receive and distribute air equally
- 6- There must be absolutely no objects such as TVs, electrical outlets, refrigerators, other electrical and electronic devices, battery-operated toys, beds, etc., located below where the indoor unit is mounted.
- 7-

ASSEMBLY GUIDE - Important points to note.

Private Vehicles

Name of Tool/Equipment	Usage Requirements
Vacuum Pump	An explosion-proof vacuum pump should be selected. The accuracy value should be less than 10 Pa (Pascal). should be.
Refrigerant Filling Machine	It must be made of special explosion-proof filling devices. The deviation must be precise, less than 5 grams.
Leak detector	It must have been calibrated. The annual leakage value should not exceed 10 grams.
Concentration detector.	A- The assembly and maintenance area must have a refrigerant leak alarm and be connected to the building alarm system, if available. B- The work area must have a light and sound alarm designed to alert personnel during work, for the coolant. C- Leak detectors should be checked and calibrated regularly. D- It is necessary to check and test these detectors before using them.
Manifold	A- Pressure gauges must be calibrated. B- Manifold sets used with R290 and R161 refrigerants can be used in R22 refrigerant systems. Manifold sets designed for R410a refrigerants can also be used in systems using R32 refrigerant.
Fire extinguisher	Fire safety measures are necessary during maintenance and installation. The work area should be dry and contain carbon dioxide. Two or more chemical or foam-type fire extinguishers must be in a ready position. It should be deployed in an area where a rapid response is possible in the event of a potential flare-up.

ASSEMBLY GUIDE - Selecting the assembly location

INDOOR UNIT

- Mount the indoor unit to a strong wall that is not subject to vibrations.
- Input and output ports must not be blocked:
- Air should be able to be blown throughout the room.
- Do not mount the unit near a heat or steam source.
- Place the unit near an electrical outlet.
- Do not install the unit in a location where it will be exposed to direct sunlight.
- Choose a location where the condensed water can easily drain.
- The outside and the place where it is easily connected to the outdoor unit.
- Check the machine's operation regularly and
- Be sure to leave the spaces shown in the image.
- Install the filter in a location where it can be easily removed.

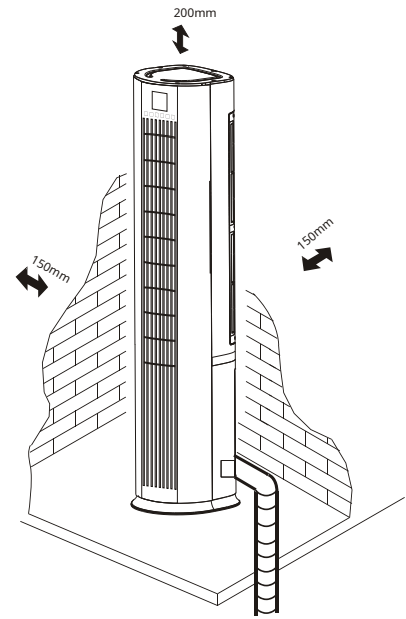

OUTDOOR UNIT

- Do not install the outdoor unit near heat or steam sources, or in an area containing flammable gases.
- Do not install the unit in very windy or dusty locations.
- Do not install the unit in areas with heavy pedestrian traffic.
- Choose a location where air ventilation and operating noise won't disturb neighbors.
- Avoid installing the unit in a location where it will be exposed to direct sunlight (otherwise, use a protective covering that does not obstruct airflow).
- Fill in the blanks as shown in the image.
- roam freely.
- Place the outdoor unit in a safe and secure location.
- If the outdoor unit is subjected to vibration, place rubber seals on the unit's feet.

Minimum gaps that must be left

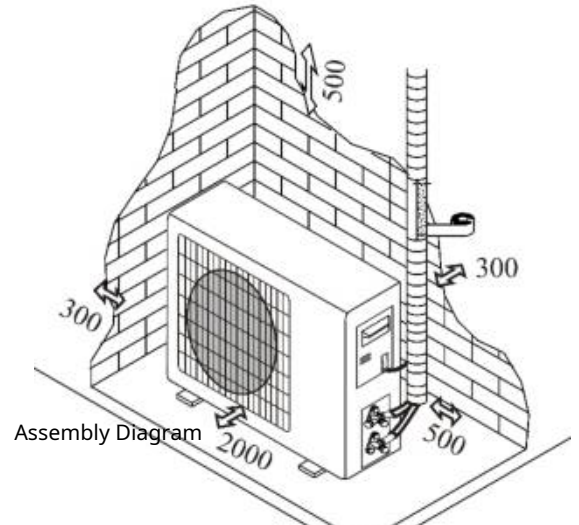

Assembly Diagram

The products must be assembled by qualified personnel.

The height difference between the indoor and outdoor units is more than 5 meters.

That's not possible. The length difference between the indoor and outdoor units cannot exceed 15 meters.

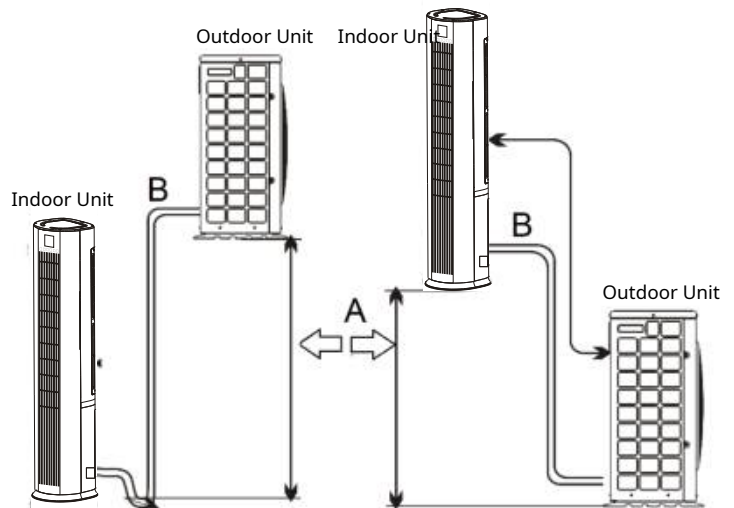

INSTALLATION GUIDE - Installation of the indoor unit

Before the assembly, determine the position of the units.

Make your decision considering the minimum available spaces.

Do not place your air conditioner in an excessively humid room such as a bathroom or laundry room.

Do not assemble.

The hole to be drilled for piping.

1. Adjust the hole for the pipes according to the position of the indoor unit. 2. Secure the wall.

And to keep it clean, insert the guide plastic piece into the hole in the wall.

2. The hole should be angled from the inside out and downwards.

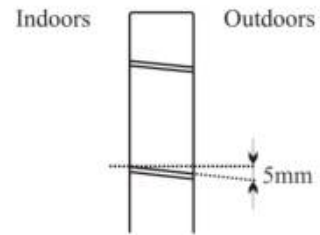

Indoor unit electrical connections.

1. Lower the front panel as shown in the image.

2. Remove the panel from the indoor unit.

3. Remove the cover by unscrewing the screw as indicated on the cover.

4. For electrical connections, the right side of the unit located under the front panel.

Look at the circuit diagram on that side.

5. Follow the numbering and connecting the cable wires to the screw terminals.

Use a cable cross-section suitable for the electrical input (see label on the unit).

and according to the requirements of existing local security regulations

Apply it.

The cable connecting the indoor and outdoor units must be suitable for outdoor use.

A productive soil connection must be established.

 If the power cable is damaged, it must be replaced by an Authorized Service Center.

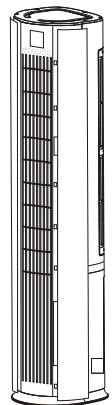

Electrical Circuit Diagram

Electrical Connections cover

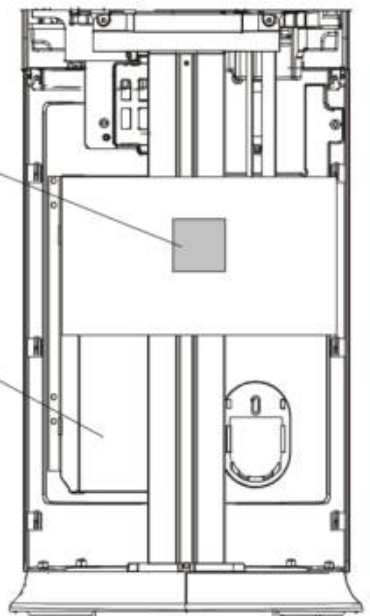

INSTALLATION GUIDE - Installation of the indoor unit

Coolant pipe connection

Arrange the copper pipes as shown in the picture, with the drainage pipe at the bottom.

And tape them all together. Use decorative tape to keep all the pipes together.

Ensure that the water can flow freely.

To prevent moisture or dirt from entering, seal your pipes

the cover on the pipes until they are connected

Do not remove it. The pipe will stiffen if bent or pulled too hard.

and it will break. Do not bend the pipe at the same point more than three times.

When unrolling the pipes, proceed as shown in the picture.

Loosen the tube slightly and straighten it.

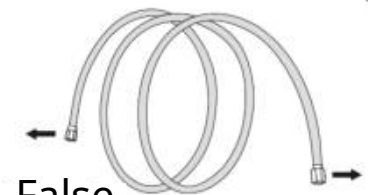
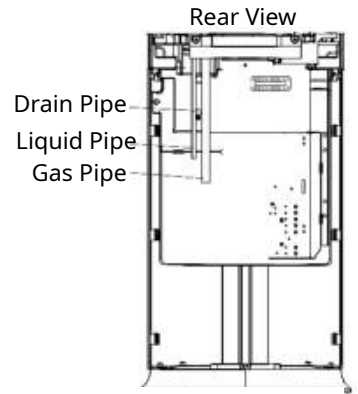

Indoor unit connections

1. Remove the indoor unit pipe cover (check that there is no dust inside).
2. Install the fitting and connect it to the end of the connecting pipe without tapping the threads.
3. Using a torque wrench, tighten the fittings in the opposite direction.

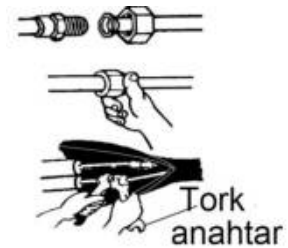

Draining the condensate water from the indoor unit.

Draining the condensate water from the indoor unit is a fundamental rule of installation.

1. Place the drain hose under the pipes and electrical cables.

And be careful not to create a siphon.

2. To aid drainage, the drain hose should be angled downwards.
3. Do not bend, increase the slope, or twist the discharge hose.

Do not leave it unattended and do not immerse the end in water. If an extension has been added to the drain hose,

Make sure the nesting is precisely delayed.

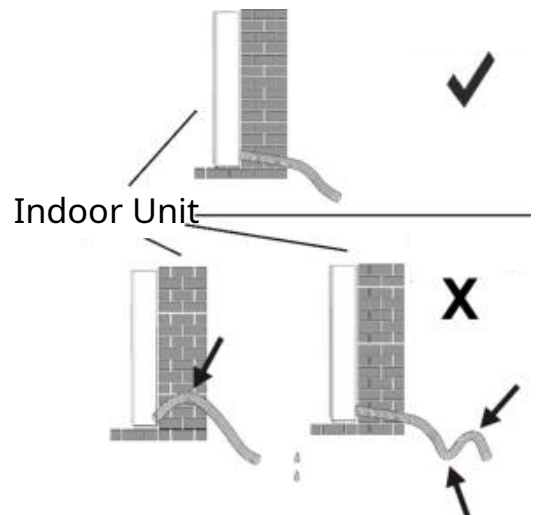

INSTALLATION GUIDE - Installation of the indoor unit

INSTALLATION OF THE INDOOR UNIT

After connecting the pipe according to the instructions, attach the connecting cables.

Install the drain pipe. After connection, connect the pipe, cables, and

Seal the drain pipe with decorative tape, not too tightly wrap it up.

1. Adjust the pipes, cables, and drain hose.
2. Place the insulation material between the pipes and secure it with electrical tape.
3. Thread the connecting pipe, cables, and drain pipe through the hole in the wall and install the indoor unit.

Securely mount it to the top of the mounting plate.

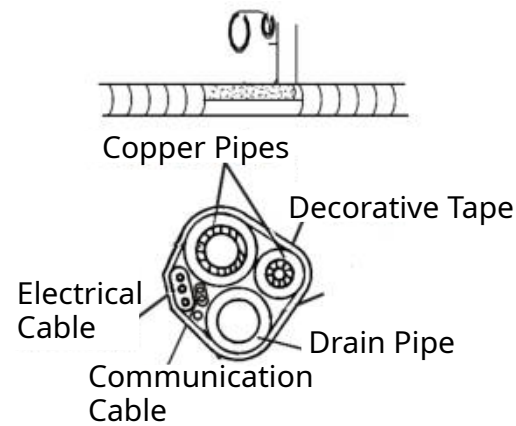

INSTALLATION GUIDE - Installation of the outdoor unit

- The outdoor unit must be mounted to a sturdy wall and securely fastened.
- Before connecting pipes and cables, the following procedure must be followed:
- Decide on the best position on the wall and leave enough space for comfortable work during maintenance or troubleshooting.
- Secure the support to the wall using screw anchors specifically suited to the wall type; Use more screw connections than usual.
- The wall mount must withstand vibrations during operation and remain fixed in the same position for years without the screws loosening.
- The unit must be installed in accordance with local regulations/rules.

Outdoor unit condensate drain line.

Condensation water and ice formed during the heating process in the outdoor unit, can be drained through the drain pipe

1. Connect the discharge port to the unit as shown in the image.

Secure it to the 25mm hole located in one of the sections.

2. Connect the discharge port and the discharge pipe.

Make sure the water drains in a suitable place.

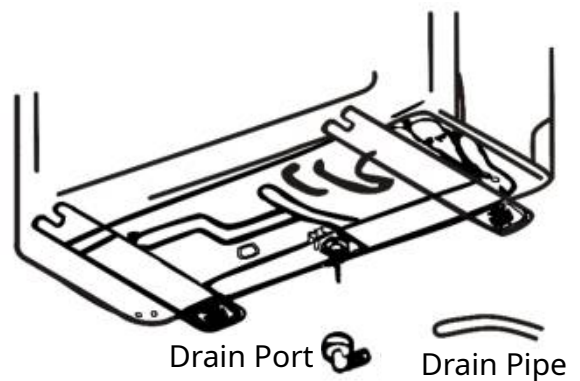

INSTALLATION GUIDE - Installation of the outdoor unit

Electrical connections

1. Remove the cover on the right side of the outdoor unit.
 2. Connect the mains cable to the terminal block.
- The wiring must match that of the indoor unit.
3. Secure the power cable with a cable tie.
 4. Ensure the cables are securely and properly fastened.
 5. The grounding line must be constructed according to TSE regulations.
 6. Close the lid.

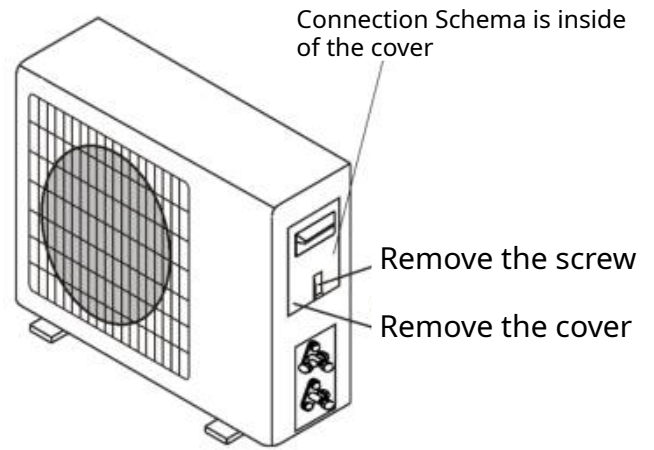

Copper pipe fittings

The fittings must be tightened using the same crimping procedures as described for the indoor unit.

Connect to the outdoor unit valves.

Please pay attention to the following points to prevent leaks:

1. Tighten the fittings using two wrenches. Do not apply excessive force.

Be careful not to damage the pipes.

2. If the tightening torque is insufficient, the system will leak.

Excessive tightening torque will damage the valve.

3. Use the table on page 22 for tightening torques.

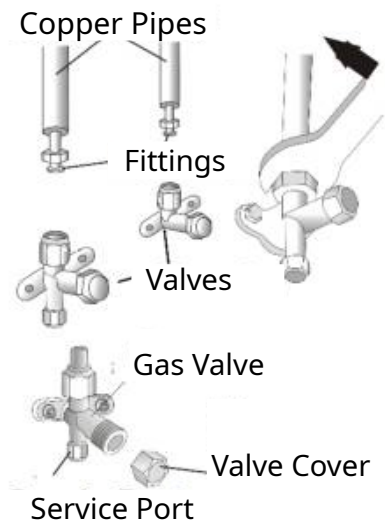

Vacuumping

Air and moisture trapped in the refrigerant circuit can cause compressor failure. After connecting the indoor and outdoor units, use a vacuum pump to remove air and moisture from the refrigerant circuit.

Coolant pressure test

The pressure value of R32 refrigerant in cooling;

The heating pressure should be 0.8-1.2 MPa (8-12 Bar);

It should be in the range of 3.2-3.7 MPa (32-37 Bar).

In air conditioners operating at pressure values other than those listed above,

An investigation is absolutely necessary in case there is a problem.

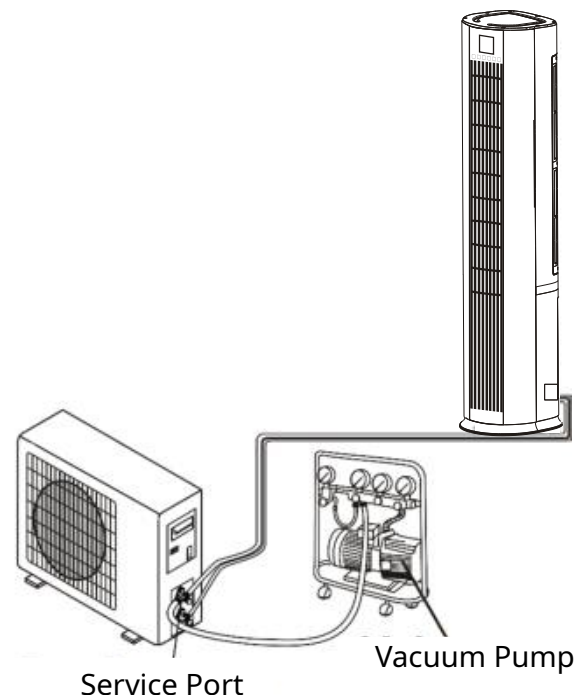

INSTALLATION GUIDE - Installation of the outdoor unit

Vacuumping

- (1) Remove the caps from the 2-way and 3-way valves.
- (2) Remove the cover from the service port as well.
- (3) Connect the vacuum pump hose to the service port.
- (4) Turn the vacuum pump until an absolute vacuum of 10 mm Hg is reached.

Run the system for 30-45 minutes, depending on the length of the installation.

- (5) Close the vacuum pump suction valve while the vacuum pump is running.

Next, stop the vacuum pump. Check for leaks using a sensitive vacuum gauge.

Check it.

- (6) Turn the 2-way valve a quarter turn to open it and close it after 10 seconds.

Clean all connection points and ports on the valve with liquid soap or

Perform a leak check using an electronic leak detection device.

- (7) Loosen the screws on the cores of the 2-way and 3-way valves all the way.

Remove the hose if no additional refrigerant charge is required.

- (8) Close and tighten all the caps on the valves.

3-way valve

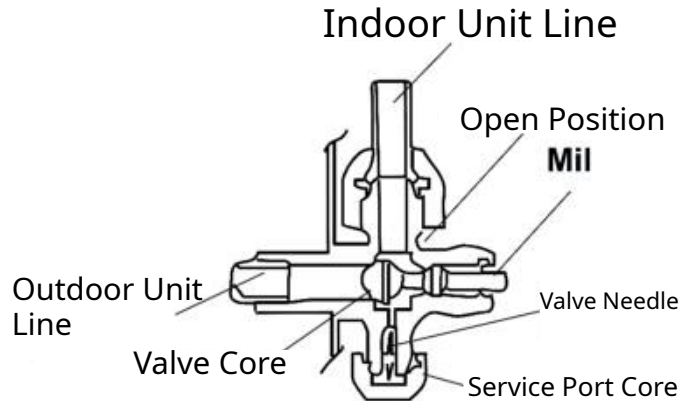

ASSEMBLY MANUAL - Operation and testing

1. Wrap the insulation around the indoor unit connections and secure it with insulation tape.
2. Secure the excess portion of the signal cable to the pipe or outdoor unit.
3. Secure the pipes to the wall (after covering it with insulation tape) using clamps, or place them in plastic slots.
4. Seal the hole through which the pipe passes so that air or water cannot fill it.

Indoor unit test

Are the ON/OFF and FAN buttons and modes functioning correctly?

Is the MODE button working properly?

Is the TIMER working correctly?

Are the LEDs on the dashboard working normally?

Are the air deflection vanes/flaps functioning?

Is the condensed water being drained?

Is there any abnormal noise or vibration during operation?

Could noise, air currents, or heavy water drainage disturb the environment?

Is there any refrigerant leakage? **Note: The compressor is allowed to operate after 3 minutes after the device is powered on.**

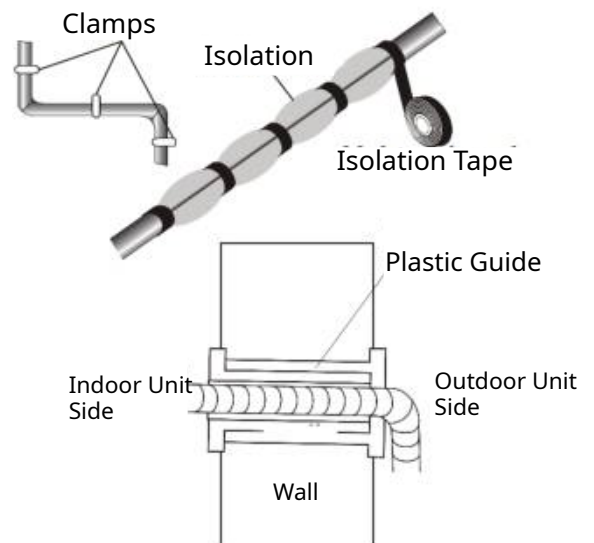

ASSEMBLY GUIDE - Information for the assembler

Product Capacity	9k / 12k	18k / 24k
Standard Refrigerant Charge	4m	4m
Maximum installation length between indoor and outdoor units	15m	15m
Maximum height difference between indoor and outdoor units	5m	5m
Refrigerant Type	R32	R32

(1) Please base your calculations on the values on the outdoor unit label.

(2) The total charge amount and maximum piping distance should be determined according to Table GG on page 20.

Tightening Torque Values

Pipe Cross-Section	Tightening Torque (N x m)	The corresponding force 20 cm wrench.		Tightening Torque (N x m)
1/4 " (φ6)	15 - 20	Wrist Strength	Servis port somunu	7 - 9
3/8 " (φ9.52)	31 - 35	Arm Strength	Koruma kapakları	25 - 30
1/2 " (φ12)	35 - 45	Arm Strength		
5/8 " (φ15.88)	75 - 80	Arm Strength		

CIRCUIT DIAGRAMS

Different models may have different circuit diagrams. Please refer to the circuit diagrams on the product.

Electrical circuit diagrams are located under the front panel on indoor units and on the back of the handle on outdoor units.

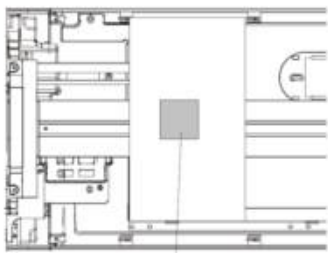

Electrical Circuit Diagram

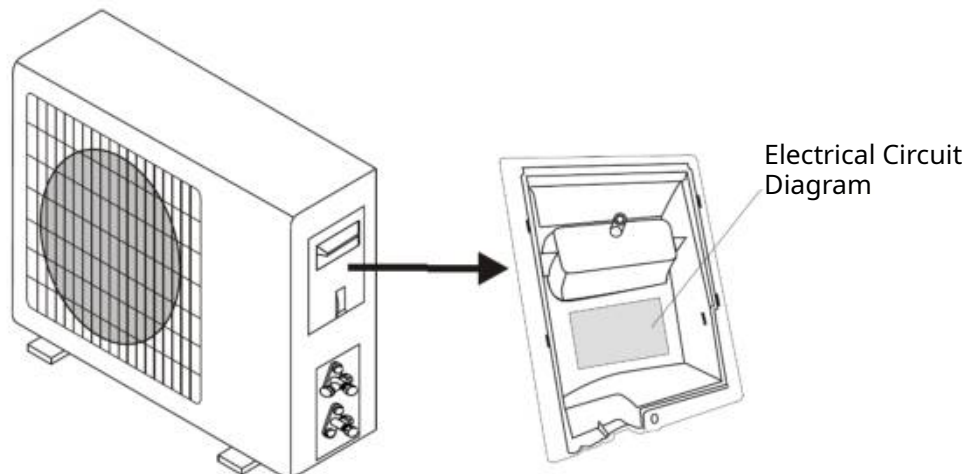



Electrical Circuit Diagram

Note: In some models, the cables are directly connected to the units and there is no connection terminal.

ASSEMBLY GUIDE - Information for the assembler

CABLE CROSS-SECTIONS

Product Model Capacity (x 1000 Btu/h)		18k	24k	36k	42k	48k
		Cable Cross-Sectional Area				
Grid Cable	N	2.5mm ² AWG12	2.5mm ² AWG12	2.5mm ² (4.0mm ³)	—	(1.5mm ³)
	L	2.5mm ² AWG12	2.5mm ² AWG12	2.5mm ² (4.0mm ³)	—	0.75mm ² (1.5mm ³)
	E 	2.5mm ² AWG12	2.5mm ² AWG12	2.5mm ² (4.0mm ³)	—	0.75mm ² (1.5mm ³)
	R(A)	—	—	—	2.5mm ² AWG12	2.5mm ² AWG12
	S(B)	—	—	—	2.5mm ² AWG12	2.5mm ² AWG12
	T(C)	—	—	—	2.5mm ² AWG12	2.5mm ² AWG12
	N	—	—	—	2.5mm ² AWG12	2.5mm ² AWG12
		—	—	—	2.5mm ² AWG12	2.5mm ² AWG12
Wiring Cable	N	1.5mm ²	2.5mm ²	0.75mm ² (1.5mm ³)	0.75mm ² (1.5mm ³)	—
	L	—	2.5mm ²	0.75mm ² (1.5mm ³)	0.75mm ² (1.5mm ³)	—
		1.5mm ²	2.5mm ²	0.75mm ² (1.5mm ³)	0.75mm ² (1.5mm ³)	—
	1	1.5mm ²	0.75mm ² (2.5mm ³)	0.75mm ²	0.75mm ²	0.75mm ²
	2	0.75mm ²	0.75mm ² (2.5mm ³)	0.75mm ²	0.75mm ²	0.75mm ²
	3	0.75mm ²	0.75mm ² (2.5mm ³)	0.75mm ²	0.75mm ²	0.75mm ²
	4	—	—	0.75mm ²	0.75mm ²	0.75mm ²

The fuse rating used in the indoor unit is (50 T) / 5 A / 250 V.

RESORT

To keep your air conditioner efficient, periodic maintenance is necessary.

Before performing any installation or maintenance, turn on your air conditioner using the remote control.

Turn it off and switch the fuse to the off position.

Indoor Unit

Dust collector filters

1. Holding the filter by its handle, gently pull the filter along the direction of the arrow.

When removing part of the filter, pull out the entire filter.

2. Clean the filter with water; if the filter is dirty with oil, use warm water.

It can be washed (at a temperature not exceeding 45°C). Then, store in a cool, shaded, and dry place.

Leave it to dry somewhere.

3. Place the air filter back in its original position.

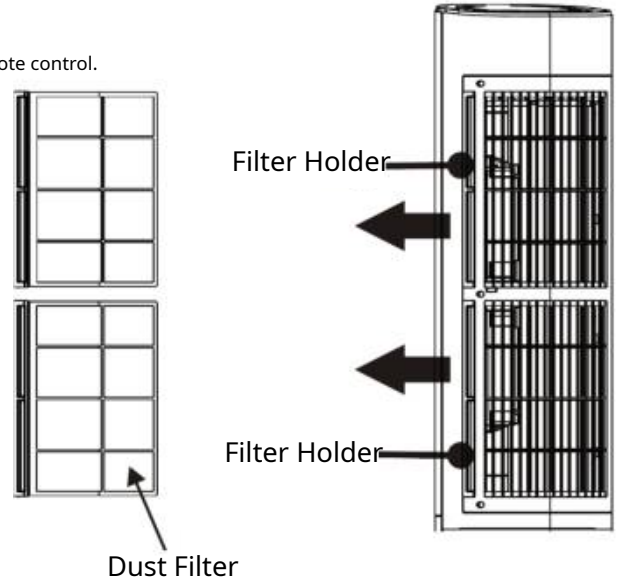

CLEANING THE HEAT EXCHANGER

1. Remove the front panel by unscrewing the screws to make cleaning easier.

2. Clean the indoor unit using a cloth and neutral soap with water (no higher than 40°C). Never use aggressive solvents or detergents.

END-OF-SEASON MAINTENANCE

1. Turn off the power.

2. Clean/wash the filters and put them back in place.

3. On a sunny day, run your air conditioner on fan mode for a few hours. Then turn it off.

REPLACING REMOTE CONTROL BATTERIES

If the air conditioner makes no sound even when you press the remote control buttons, or if it responds to commands from 1 meter away but not from 3-4 meters away, and the indicator LEDs do not light up, replace the batteries.

Remove the cover located on the back of the remote control. Remove the batteries. Insert new batteries into the remote control, paying attention to the polarity (+ and -).

WARNING! Do not dispose of batteries in public waste; they must be disposed of separately. Dispose of them in the containers located at designated battery collection points.

TROUBLESHOOTING

TROUBLE TYPE	POSSIBLE CAUSES
UNIT DOES NOT OPERATE	<ul style="list-style-type: none"> • Power failure / fuse blown • Damaged indoor / outdoor fanmotor. • Faulty thermal protector or circuit breaker of compressor. • Faulty overcurrent relay or fuses. • Loose connections or disconnected wiring. • Microprocessor protection occurred, stopping unit operation. • Voltage on power supply is higher or lower than the rated voltage range. • Active TIMER-ON. • Faulty electronic control (PCB).
OPERATION EMITS STRANGE ODOR	<ul style="list-style-type: none"> • Filters may be dirty.
THERE IS WATER DRIPPING OR LEAKING	<ul style="list-style-type: none"> • The condensate drain or piping is blocked.
STEAM OR SMOKE COMES FROM AIR OUTLET	<ul style="list-style-type: none"> • If the room is very cold, steam may be emitted during heating, this is normal. • Steam or smoke may be emitted in COOLING, DEHUMIDIFYING, REHEATING mode due to moisture on the heat exchanger blocks.
UNIT EMITS ODD NOISE	<ul style="list-style-type: none"> • This sound may indicate due to the expansion or contraction of front panel or other unit components due to temperature changes. • The refrigerant flowing this cooling cycle sound may be heard.
INSUFFICIENT HEATING OR COOLING	<ul style="list-style-type: none"> • Unit temperature or fan speed is not correctly adjusted. • Inlet or outlet of indoor unit is blocked. • Windows, doors open, could be a heat source.
UNIT DOES NOT RESPOND TO REMOTE CONTROL	<ul style="list-style-type: none"> • Remote control batteries may be flat. • Remote control batteries may need replacing. • Remote control signal transmitter or receiver in defective position. • There is an electronic control issue at unit end.
FRONT PANEL INDICATOR IS DIMMED	<ul style="list-style-type: none"> • Indicator light is dimmed from remote control.

Turn off the air conditioner and remove the fuse under the following situations:

- If you hear strange noises during operation.
- If there is a malfunction of the PCB.
- If fuses blow or there is a leakage current issue.
- If the unit is hit, shaken, or if foreign objects enter into its interior.
- In case of damaged cable or fuse box is smoldering.
- If you smell something sharp.

ERROR CODES ON DIGITAL DISPLAY

Fault situation, under fault situations, under fault codes on error codes there cool:

RUN Lamp	Blinks	Error Description
E1	Blinks once	Indoor unit temperature sensor fault
E2	Blinks twice	Indoor unit pipe temperature sensor fault
E5	Blinks five times	Outdoor unit protection. Outdoor unit high exhaust pipe temperature, wiring connection fault or anomaly, or over-current or high pressure problem.

TRANSPORTATION / STORAGE / MAINTENANCE / REPAIR / RECYCLING INSTRUCTIONS

1. Transportation of equipment containing flammable coolants. Must comply with local transportation regulations.
2. Labeling of devices using markings: Must comply with local regulations.
3. Disposal of equipment using flammable refrigerants. This must comply with local regulations.
4. Storage of equipment/devices: Equipment should be stored in accordance with the manufacturer's instructions.
5. Storage of packaged (unsold) equipment: Product packaging protection must be done in a way that does not cause mechanical damage to the equipment inside the package or leakage of refrigerant.

The maximum number of devices allowed to be stored together is determined by local regulations.

6. Service Information

- 1) On-site checks: Before commencing work on systems containing flammable coolants, safety checks are necessary to minimize the risk of ignition. For cooling system repairs, the following precautions must be observed before any work is carried out on the system.
- 2) Work procedure: To minimize the risk of exposure to flammable gases or vapors during work, the work must be carried out in a controlled manner.
- 3) General work area: All maintenance personnel and other persons working in the assembly/maintenance area will be informed about the work. Working in confined spaces will be avoided. The area around the work area will be fenced off. Ensure that the conditions in the area and flammable materials are kept under control.
- 4) Checking for refrigerant: The work area should be checked with a suitable refrigerant detector before and during work to ensure the technician is aware of potentially flammable environments. Ensure that the leak detection equipment used is suitable for use with flammable refrigerants, ie, non-sparking and intrinsically safe.
- 5) Fire extinguisher: If welding or similar work is to be performed on cooling equipment or related parts, appropriate fire extinguishing equipment must be available. Dry chemical powder or CO₂ fire extinguishers should be present in the work area.
- 6) No ignition source: Persons working with a cooling system containing flammable coolant must eliminate all threats that could cause ignition or fire. All potential sources of fire and/or sparks, including smoking, must be kept far enough away from the assembly, repair, disassembly, and disposal area where flammable coolant could potentially be released into the environment. Before commencing work, the area around the work site should be surveyed to ensure there are no flammable hazards. Alternatively, signs indicating risks such as "No Smoking" or "Do Not Bring Near with Fire" should be posted.

7) Well-ventilated area.

Ensure the area is clear and adequately ventilated before beginning any work on the system, such as welding or electrical work. Ventilation should be maintained throughout the duration of the work. The ventilation should safely disperse any released coolant, preferably to the outside atmosphere.

8) During inspections of cooling equipment, where electrical parts are replaced, they must be suitable for the purpose and specifications. Always follow the manufacturer's maintenance and service guidelines. In case of any uncertainty, consult the manufacturer's/importer's technical department for assistance.

In facilities using flammable refrigerants, the following checks must be carried out:

- The charging amount depends on the size of the room in which the refrigerant-containing units are installed;
- Ventilation fans and their outlets must be functioning properly and must not be obstructed;
- If an indirect cooling circuit is used, the secondary circuit should be checked for the presence of refrigerant;
- Equipment markings must remain visible and legible. Illegible markings and signs must be verified;
- Coolant pipes or components are installed in a location where they will not be exposed to any substances that could corrode the coolant-containing components, unless the components are made of materials that are wear-resistant or adequately protected against corrosion.

9) Checks performed on electrical devices

Repair and maintenance of electrical components should include initial safety checks and component inspection procedures. If a fault is found that could compromise safety, then no electrical supply should be connected to the circuit until it has been satisfactorily addressed. If the fault cannot be corrected immediately, but it is necessary to continue operation, an appropriate workaround will be used. This will be reported to the owner of the equipment, thus informing all parties. Initial safety checks will include: checking that capacitors are discharged: this must be done safely to prevent sparks; ensuring that no live electrical components and wiring connections are exposed while charging, recovering, or discharging the system; oath ensuring the continuity of the ground connection.

Repair Enclosed Components

1) During the repair of sealed components, the equipment being worked on must be disconnected before removing all electrical materials, sealing covers, etc. If it is absolutely necessary to provide an electrical supply to the equipment during servicing, a permanent working method should be used. Leak detection should be placed at the most critical point that could potentially trigger a leak. dangerous situation.

2) When working on electrical components, particular attention should be paid to ensure that the enclosure is not modified in a way that affects its level of protection. This includes damage to wiring, excessive connections, terminals that do not conform to the original specifications, damaged seals, incorrectly installed fittings, etc. Ensure that the device is securely mounted. Ensure that seals or gaskets are not damaged in a way that prevents the entry of flammable atmospheres. Replacement parts will conform to the manufacturer's specifications.

TRANSPORTATION / STORAGE / MAINTENANCE / REPAIR / RECYCLING INSTRUCTIONS

NOTE: The use of silicone sealant may interfere with the effectiveness of some leak detection equipment. It is inadvisable to isolate flammable, explosive parts before working on them.

8. Repair of parts at risk of burning;

Do not apply permanent inductive or capacitive loads to the circuit without ensuring that the voltage and current will not exceed the permitted limits for the equipment being used. The test device must be accurate and calibrated. When you need to replace parts used in the product, replace them only with parts specified by the manufacturer. Using aftermarket parts may cause the coolant to ignite due to a leak.

9. Cabling

Ensure that the cables are not exposed to abrasion, corrosion, excessive pressure, vibration, sharp edges, or other adverse environmental effects. These checks should also consider the effects of aging or continuous vibration from sources such as compressors or fans.

10. Detection of flammable refrigerants

Under no circumstances may potential ignition sources be used in refrigerant leak detection or testing. A halogen lamp (or any detector using an open flame) shall not be used.

11. Leak detection methods

The following leak detection methods are considered acceptable

In systems containing flammable refrigerants, electronic leak detectors should be used to detect leaks of flammable refrigerants. These detectors may have insufficient sensitivity or may require calibration. (The detection device should be calibrated in an area free of refrigerant.) Ensure the detector is not a potential ignition source and is suitable for the refrigerants being used. Leak detection equipment should be set to a percentage of the refrigerant's LFL (Lower Flammability Limit) and calibrated for the refrigerant being used, and the appropriate gas percentage (maximum 25%) should be verified. Leak detection fluids are suitable for use with most refrigerants, but the use of detergents containing chlorine should be avoided, as chlorine can react with the refrigerant and corrode copper tubing.

If a leak is suspected, all sources of flame or spark generation must be removed/extinguished. If a refrigerant leak requiring welding is found, all refrigerant must be recovered from the system, or if the leak is in a remote section of the system, it must be repaired after closing the valves. The system should be flushed with nitrogen (oxygen-free).

12. Transportation and unloading

When repairing or intervening in a refrigerant system for any other purpose, conventional procedures should be used. However, given the risk of flammability, determining best practice is crucial. The following procedure must be followed.

Discharge the coolant.

Clean the system with nitrogen gas;

Empty it completely;

Evacuate again with inert gas;

Remove the pipes in the system by cutting or welding them. Note: If welding is required, ensure that no refrigerant remains in the system.

TRANSPORTATION / STORAGE / MAINTENANCE / REPAIR / RECYCLING INSTRUCTIONS

Refrigerant charging must be done into the correct return tubes. To make the unit safe, the system must be flushed with OFN. This process may need to be repeated several times. Compressed air or oxygen should not be used for this process. Flushing is achieved by breaking the vacuum in the system with OFN, continuing to fill until working pressure is achieved, then venting to the atmosphere and then drawing it into a vacuum. This process must be repeated until no refrigerant remains in the system. When the final OFN charge is used, the system must be reduced to atmospheric pressure to allow the work to be done. This is absolutely crucial if welding operations are to be performed on the piping. Ensure that the vacuum pump outlet is not near any fire source and that ventilation is available in the environment.

13. Refrigerant charging procedures

In addition to standard charging procedures, the following guidelines should be followed.

- Ensure that different refrigerants are not used when charging equipment is in use. Hoses should be as short as possible to minimize the amount of air trapped inside them.
- Refrigerant cylinders must be kept upright.
- Before filling the system with coolant, ensure that the cooling system is properly grounded.
- Label the system when charging is complete.
- Care should be taken to avoid overcharging the cooling system with refrigerant.

The system must be pressure tested with OFN before charging. A leak test must be performed before commissioning once the charging process is complete. A leak test must be performed in the environment before leaving the installation/maintenance area.

14. Disabling

Before implementing these procedures, technicians must have a complete understanding of all the details of the equipment and system. All refrigerants must be collected safely. Prior to this, an oil and refrigerant sample will be taken before the collected refrigerant is reused or if analysis is required. It is important that the electrical connection and power supply are available before starting work.

- a) You must know the equipment and how it works.
- b) Electrically isolate the system. You must check for leakage and/or grounding lines.
- c) Before starting the process, check the following:

If necessary, is mechanical handling equipment available for transporting the refrigerant cylinders?

Do you have all the necessary personal protective equipment and do you know how to use it correctly?

The recycling process is always supervised by an authorized person;

Are the recycling equipment and tubes compliant with standards?

- d) If possible, was the refrigerant system vacuumed?
 - e) If vacuuming is not possible, set up a mechanism to remove the refrigerant from various environments.
 - f) Were the coolant cylinders and scales correctly positioned before starting the process?
 - g) Was the recycling machine started and was the refrigerant collected according to the manufacturer's instructions?
 - h) Do not fill the tubes with liquid exceeding 80% of their maximum volume.
 - i) Do not exceed the maximum operating pressure of the cylinder, even temporarily.
 - j) Were the cylinders filled correctly and, once the process was complete, were the cylinders and equipment removed from the site immediately?
- Were all valves on the conversion device closed?

k) The collected refrigerant cannot be charged into another cooling system until it has been cleaned and checked.

15. Labeling

The unit will be labeled indicating that it has been deactivated and the refrigerant has been drained.

Labels must be dated and signed. Ensure the device has labels indicating the presence of flammable refrigerant.

16. Rescue

When collecting refrigerant from a system for servicing or decommissioning, all refrigerant must be collected safely.

When transferring refrigerant to cylinders, ensure only suitable refrigerant recovery cylinders are used. Ensure there are enough cylinders to hold the total system charge. All cylinders used must be designed for recycling.

Refrigerant and cylinders labeled for that refrigerant (ie, cylinders specifically designed for refrigerant recovery). The cylinders must be in good working order with pressure relief valves and associated shut-off valves. Empty recovery cylinders are emptied and, if possible, cooled before recovery takes place.

The recovery equipment will be in good working order and suitable for the recovery of flammable refrigerants, along with a set of instructions regarding the equipment at hand. In addition, a set of calibrated weighing scales will be available and in good working order. Hoses must be complete and in good condition with leak-proof disconnect couplings. Before using the recovery machine, ensure it is in satisfactory working order, properly maintained, and that all relevant electrical components are sealed to prevent ignition in the event of a refrigerant release. Consult the manufacturer in case of doubt.

The recovered coolant is returned to the coolant supplier in the correct recovery cylinder, and the relevant Waste Transfer Note is issued. Do not mix coolants in recovery units, and especially in cylinders.

If compressors or compressor oils are to be removed, ensure they are drained to an acceptable level to prevent any flammable refrigerant from remaining in the lubricant. The draining process must be completed before returning the compressor to the suppliers. To expedite this process, electric heating will be applied only to the compressor housing. When oil is drained from a system, it must be done safely.

PERIODIC MAINTENANCE, TIME AND METHOD

Regular maintenance is necessary to remove dust, microbe, bacterial-like particles, and other particles circulating in the air environment through air conditioners, and periodic maintenance is necessary for human health, energy savings, and extending device lifespan and certain times during usage since there are many usage:

Filter and panel cleaning: This maintenance is performed by the customer. The air conditioner's filter panel is opened, the dust filters are removed and cleaned with compressed air or lukewarm water. After drying, it is reinstalled. Under normal use, maintenance should be done every 15 days; however, in environments with very high dust and dirt levels, maintenance should be performed more frequently depending on how often the dust and dirt accumulate.

General Maintenance: This maintenance performed by the authorized service technician. The evaporator and condenser coils are cleaned under this maintenance. Chemical cleaning should be done to protect human health during the indoor unit break down, remove millipedes and molds to gradually remove the dirt over the condenser to prevent blocking and algae formation in the drainage pan.

It is recommended that general maintenance be performed by an authorized service center at least twice a year (during seasonal changes).

INFORMATION ON EFFICIENT USAGE IN TERMS OF ENERGY CONSUMPTION

Air conditioner is strongly efficient by selecting different Air energy efficiency, under fault codes is increase.

- Choosing a device with the appropriate capacity for the environment in which it will be used will increase energy efficiency.
- The air conditioner temperature correctly will increase the lifespan and reduce operating costs and energy costs and electricity expenses.
- Energy efficient operation will be ensured when the temperature set between 24-26 C degree
- Close the doors and windows in places where air conditioner is used at once time.
- Measures as related to heat insulation of the environment will be vital through when it with the product's life span.
- Use seasonal transitions by fan mode of playing.
- Ensuring the air conditioner's duct system is constructed to the correct dimensions will reduce energy consumption.
- With seasonal transitions, use only fan mode during seasonal transitions to reduce energy consumption.
- Using the appliance in fan mode only during seasonal changes will reduce energy consumption.